

2016-17

A GOAL FOR EVERY GAME

Team Sports and Park & Rec Equipment



**NJ State
Contract!**





Quick View Index

Badminton 63, 64
Ball & Equipment Carts..... 24, 59, 62
Bike Storage..... 99
Competition Basketball 4-7, 10, 16-22
Competition Soccer..... 66-71
Competition Volleyball 40-61, 63
Court & Field Diagrams..... 104-105
Custom Graphics, Lettering & Logos..... 24, 26-39, 58, 74, 80, 91, 102
Divider Curtains & Nets 15
Football..... 73-74
Futsal 76
Gym Construction & Renovation 3, 5
Hockey (Field) 76
Hockey (Ice)..... 75
Lacrosse..... 75
Landscape Site Furnishings..... 99
Multi-Game Bases & Standards..... 14
Outdoor Basketball 82-98
Outdoor Volleyball 56-57
Pickleball 65
Portable Basketball Systems..... 10-14
Portable Soccer Goals 67-69
Portable Volleyball Standards 52-55
Receptacles, Litter & Recycling..... 99
Residential Basketball 100-101
Rugby 71, 74
Scoreboards & Electronics..... 25
Scorebooks 108
Scorers & Activity Tables 27-30
Seating 31, 77-81, 99
Team Handball..... 76
Tennis 65
Tetherball 64
Training Aids 22, 62, 72
Wall Mounted Basketball Systems 4-9
Wall Padding (Indoor & Outdoor)..... 32-37
Wind Screens..... 38
Youth Basketball 6-9, 14, 23

Bison Limited Warranties

All Bison products are warranted against manufacturing defects at the time of delivery. In addition, most products are covered by warranty periods stated in the description of the product. Where listed as "limited", warranties cover damage or failure that occurs during the course of "normal or intended use" of the warranted product. Normal or intended use is described as activity that is necessary for the participation in the sport for which the equipment is designed.

Bison Limited Warranties do not cover any damage or failure that is the direct or indirect result of any use that is not deemed in the sole discretion of Bison to be "normal and intended use".

When warranties are stated as "unconditional" or "unconditional replacement", the above stated limitations do not normally apply except in cases where damage was obviously the result of a malicious act of vandalism.

Where no specific length or type of warranty is listed in the catalog, the product is warranted to be free from manufacturer's defects and for the intended purpose at the time of shipment.

Whether or not stated as such, all Bison warranties allow Bison to repair or replace warranted products at Bison's sole option.

Normal deterioration of products due to weather, wear and tear, or other causes that do not affect functional use are not covered by Bison warranties, regardless of type of stated warranty.

All warranties are valid only when product is used in the intended application as outlined in Bison's printed literature, when installed according to Bison's instructions and when matched with compatible components as described in Bison's literature. Under no circumstances will product shown in the Bison Premium Residential Basketball Equipment Catalog be warranted for commercial or institutional use.

Due to the abusive nature of pay-to-play facilities, unless specifically agreed to in writing, Bison products carry no warranty except for obvious manufacturing defects when used in a facility where players pay an individual or group fee to use Bison equipment.

Bison will pay ground freight only to repair or replace defective merchandise. Unless otherwise stated, Bison will not assume any liability for labor costs incurred for removal or replacement of product replaced or repaired under warranty.

Bison Return Policy

No merchandise may be returned without prior authorization by calling 800-247-7668. Merchandise returned without a return authorization number will be held for no more than 10 days at which time all return credit is forfeited. Upon receipt of request for return, an authorization number will be issued by Bison and must appear on all return shipping labels. All returns must be shipped prepaid (UPS, FedEx or truck only) to 1100 SW 6th Street, Lincoln NE 68522. Collect returns will not be accepted.

Credit for defective merchandise will be issued only when our inspection department determines the merchandise to be covered by our warranty. All salable merchandise returned is subject to a 20% restocking charge and all freight costs with a minimum restocking charge of \$30. Due to their custom design, scoring tables and wall padding are not returnable.

DO NOT RETURN BY US POSTAL SERVICE



Bison's acquisition of Institutional Products Incorporated of Indianapolis, positioned Bison to take its strong reputation for quality, customer service, product creativity and value to the Gymnasium Construction and Renovation Market. IPI sales, engineering and production functions are now located in Lincoln, Nebraska, the headquarters and manufacturing location of Bison.

While Bison has, for almost 30 years, built its brand based on its "Goal For Every Game" philosophy, until now we have only operated on the fringes of the Gym Construction Market instead concentrating on our broad replacement and loose gym and field sports equipment offerings.

Facility Owners, Architects and Contractors

Full product specifications for all IPI by Bison products are available online at www.IPIbyBison.com and can also be viewed at www.CADDetails.com. Call for the name of an IPI dealer in your area.

Bison Dealers

While as an established Bison dealer, you have access to the full line of products available in this Bison catalog, you may also qualify to become an IPI by Bison dealer gaining full access to the custom products that define the Gym Construction and Renovation Market including custom ceiling and wall basketball structures, divider curtains, multi sports cages and a wide range of wall, column and stage padding.

If you believe you have the resources to be actively involved in specifying, ordering and installing IPI by Bison gym equipment and wish to investigate becoming a dealer, contact Nik Ditzler at IPI by Bison at 800-637-7968.

You may also qualify for a "finders fee" on a sale of a competition portable basketball system from our sister company.

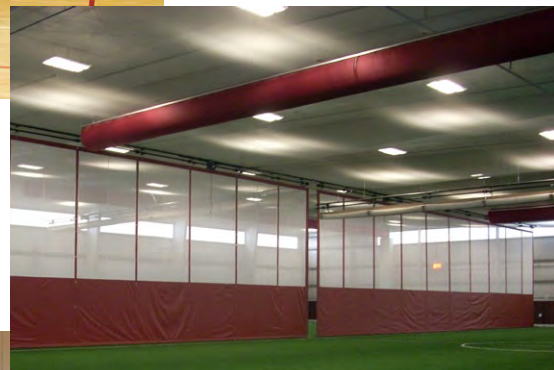
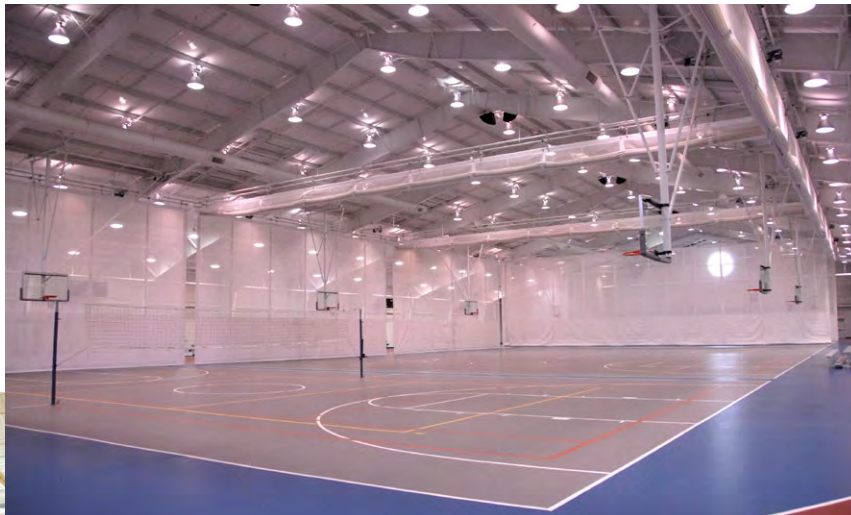

Stationary and Side Fold

Complete wall mount structure packages in-stock for immediate delivery.

IN-STOCK

Stationary

Structures adjust backboard face anywhere from 48" to 144" from wall at time of installation... Easy-to-order and install telescoping structures • Available for immediate delivery • Extra heavy steel tubular design with silver powder coated finish • Packages include structure, wall boards, support chains, Unbreakable 42" x 72" glass backboard, breakaway goal, DuraSkin backboard padding (choose from 17 colors), instructions and all mounting hardware except that required to anchor wall boards to wall • If you need height adjustability see page 6 for optional goal height adjusters • **Lifetime limited warranty on wall mount structures.**

Side Fold

Swing left or right for storage close to wall without tools or ladders... Structures position backboard face anywhere from 48" to 144" from wall at time of installation without field modification • Available for immediate delivery • Extra heavy, steel tubular design with silver powder coated finish • Heavy, solid steel, machined pivot bushings with 5/8" grade 5 pivot bolts (not just a hole drilled into tubing!) • Slotted mounting brackets for fine tuning goal height • Packages include structure, wall boards, support chains, Unbreakable 42" x 72" glass backboard, breakaway goal, DuraSkin backboard padding (choose from 17 colors), release hook, instructions and all mounting hardware except that required to anchor wall boards to wall • If you need height adjustability see page 6 for optional goal height adjusters • **Lifetime limited warranty on wall mount structures.**

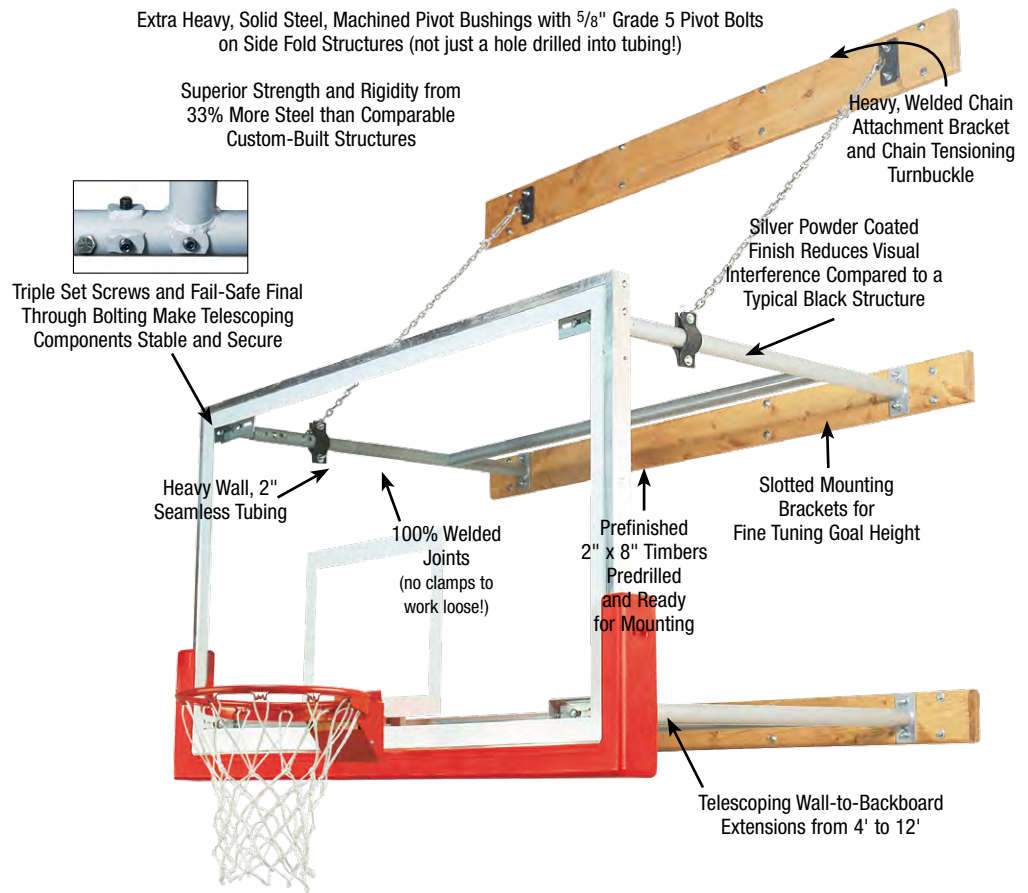

Telescoping Structures for Fail-Safe Measuring...
 There is no need to compute exact extension requirements before ordering wall mounted structures from Bison. Our structures are specially designed to allow adjustment within a specified range at installation. You'll also avoid costly field modifications caused by measurement mistakes.

Package Model #	Wall-to-Backboard Extension Range	Components Included	Approx. Shipping Weight
STATIONARY			
PKG46STRG	48" to 72"	BA42XL Official Unbreakable Short Glass Rectangular Competition Backboard, BA35S Elite Competition Breakaway Goal, BA68U DuraSkin Padding	470# Truck
PKG68STRG	72" to 96"	BA42XL Official Unbreakable Short Glass Rectangular Competition Backboard, BA35S Elite Competition Breakaway Goal, BA68U DuraSkin Padding	500# Truck
PKG82STRG	96" to 144"	BA42XL Official Unbreakable Short Glass Rectangular Competition Backboard, BA35S Elite Competition Breakaway Goal, BA68U DuraSkin Padding	580# Truck
SIDE FOLD			
PKG46SFRG	48" to 72"	BA42XL Official Unbreakable Short Glass Rectangular Competition Backboard, BA35S Elite Competition Breakaway Goal, BA68U DuraSkin Padding	490# Truck
PKG68SFRG	72" to 96"	BA42XL Official Unbreakable Short Glass Rectangular Competition Backboard, BA35S Elite Competition Breakaway Goal, BA68U DuraSkin Padding	535# Truck
PKG82SFRG	96" to 144"	BA42XL Official Unbreakable Short Glass Rectangular Competition Backboard, BA35S Elite Competition Breakaway Goal, BA68U DuraSkin Padding	585# Truck

SHOWN

CAUTION!
 Wall structure purchaser assumes mounting liability.
 See Page 105 for Safety Warning





In addition to Bison's in-stock stationary and side fold basketball system packages, Bison now offers Built-to-Order (BTO) structures allowing you to choose the exact extension, backboard and rim model to suit your facility's needs.

Bison BTO structures are available in Stationary, Side Fold and Swing Up configurations in extension lengths from 4' to 10' (1' to 10' on Stationary systems). Choose structures for fan backboard mounting or rectangular backboard mounting. BTO structures include black powder coated steel structure, 2" x 8" southern yellow pine wall boards, support chains, chain tensioners and all brackets and hardware necessary for installation except the anchors to mount the wall boards to the wall. **NOTE: Bison BTO structures are only available when ordered with a Bison backboard and rim. Due to the custom nature of BTO structures, they are not returnable. Prices are quoted based on specified requirements.**

To order, specify extension (desired exact distance from wall to face of backboard) and backboard model numbers. On Swing Up structures, specify manual or 120 volt electric winch. Backboard padding, height adjusters, portable winch winders and other components are sold separately.

Stationary

Constructed of 1½" schedule 40 structural pipe (1.9" diameter), units are furnished with ¼" x 1¼" diagonal bracing and heavy welded mounting brackets. Specify **STR10WBF** for fan shaped backboards and **STR10WBR** for rectangular backboards.

Side Fold

Same 1½" schedule 40 structural pipe design but includes pivot brackets and diagonal lock bar to allow structure to swing toward the wall either to the left or right when not in play. Specify **STR15WSFF** for fan backboard and **STR15WSFR** for rectangular backboards.

Fold Up

Swing up structures have 1½" schedule 40 pipe welded assemblies for maximum stability and can be raised toward the ceiling and wall either with a manual winch mounted to the wall (**BA925**) or a 120 volt electric winch mounted either to the wall or positioned in the ceiling structure (**BA975A3**). Swing up structures include all cable, cable clamps, pulleys and brackets necessary to connect the structure to the selected winch. Specify **STR12WFUF** for fan backboard and **STR12WFUR** for rectangular backboards.

Wall Mount Structure **SAFETY WARNING!**

Due to the aggressive nature of basketball today it is likely, regardless of the level of supervision and facility rules, play will include hanging on the goal either intentionally or in the course of play. The structural failure of any component will put players or fans in danger of grave injury or even death should the structure fail. For this reason, Bison has designed all mounting brackets, hardware and structure to be of the highest quality. Your facility can feel confident installing Bison wall structures in conjunction with Bison goals, backboards and padding, assuming the safety guidelines outlined below are followed.

1. Install structure only to walls capable of supporting the load placed on the wall by the weight of the structure and the potential for additional weight of players hanging and bouncing. Generally, the further the backboard is extended from the wall the more load that is applied. Poured concrete or concrete block walls are superior. It is inadvisable to mount structure to walls with wooden or steel studs unless additional work approved by an engineer is done to provide additional support.
2. Due to the differences in wall construction, Bison does not provide the anchors to mount the wall boards to the wall. Consult a professional architect, engineer or contractor to determine safe methods for installation to your facility's walls unless you are confident in your internal facility abilities. Bison will not assume liability for the installation of any wall mount structure shown in this catalog.
3. If the wall mount structure is being installed above bleachers it is strongly recommended (but not required) by NCAA and National High School Federation rules to install a safety device similar to the Bison BA955 Saf-Lok Structure Catch. The BA955 Saf-Lok acts as a safety belt to "catch" the structure before it falls in case of failure of the wall mounting anchors or other structural components. The device mounts to the ceiling structural components.
4. It is always wise to pad the bottom of the backboard for all levels of play. NCAA and National High School Federation rules require backboard padding similar to Bison's BA68U DuraSkin for all games governed by their rules.
5. If your wall is less than 10' from the face of the backboard, it is highly recommended that the wall is padded to avoid player contact injuries. See Bison Wall Padding options on pages 32-35.
6. Many manufacturers now produce glass backboards that are nearly impossible to break during play. The small additional cost will provide peace of mind. See Bison BA42XL, BA44XL or BA48XL on pages 18-19.
7. Always follow all installation instructions carefully. Do not omit hardware or take shortcuts.
8. Once structure is installed it is advisable to inspect annually for loose bolts as the vibration of basketball play may eventually loosen wall mount anchors and the hardware.
9. Studies have shown that 42" x 72" glass backboards reduce the risk of player injury from backboard contact. Bison manufactures 48" x 72" backboards only for replacement applications.

CAUTION!

Wall mount structure requires a minimum ceiling and wall height as well as an acceptable wall mounting surface. Generally, brick or block walls are superior. It is inadvisable to mount structure to walls with wooden or steel studs unless additional work approved by an engineer is done to provide additional support. Bison does not provide wall anchors with any structure. The purchaser assumes all liability for proper selection of anchors, supporting of walls, and installation. Bison will not assume liability for the installation of any wall mounting structure shown in this catalog. Consult a professional architect, engineer or contractor to determine safe methods for installation to your facility's wall construction.

This catalog is not intended to be used as a guide for installation and use of any product.



ZipCrank™ Goal Height Adjusters

From adult to youth play in 60 seconds... ZipCrank corner mount rim height adjusters are designed to avoid reduced backboard and rim rigidity common with other height adjustable goal systems • Movable framework slides up and down on two chrome plated 1" diameter rods riding in machined steel bushings • Height adjusters are installed between the backboard and the backboard support structure and when retrofitted on existing courts moves face of backboard 3/4" toward the free throw line • May require minor field drilling on some existing retrofit applications • Adjust rim infinitely from official 10' to 8' heights and includes easy-to-read height indicator labels • Manual models are operated with the hand crank provided or with optional BA931 Cordless Winch Winder • Electric models operate with hard wired wall mounted BA975KS Wall Mounted Key Switch, BA975CLKS Keyless Switch or BA980EW Portable 110 Volt Wand (specify with order) • See chart below for ordering details including use on center strut structures • Five-year limited warranty.



Electric Actuator

Easy-to-Read Height Indicator



Manual Operation



Cordless Winch Winder Operation (BA931)



Key Switch Operation (BA975KS)

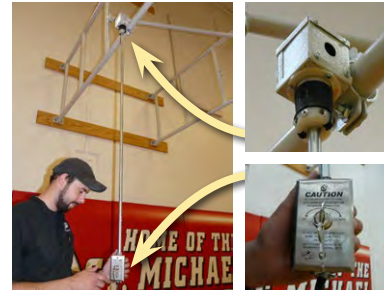

Portable Electric Wand Operation (BA980EW)

Backboard Type	Manual Operation	Electric Operation	Shipping Weight
42" x 72" backboard with 4 corner mounts	BA980RS	BA980RSE	Approx. weight: 175#; Truck
48" x 72" backboard with 4 corner mounts	BA980RT	BA980RTE	Approx. weight: 175#; Truck
Fan shaped backboard	BA980F	N/A	Approx. weight: 115#; Truck
Other backboards with approximate 35" (w) x 20" rear mounting patterns	BA980F	N/A	Approx. weight: 175#; Truck
Backboards that mount to single 6" or 6 5/8" diameter support structures	See page 16 for adapters and consult a Bison Product Specialist		

Operation Options



BA931 Cordless Winch Winder Kit
Raise and lower manual height adjusters...with this 14.4 volt, high torque drill with BA935 extension rod (included) • One-year limited warranty.
Approx. shipping weight: 25#; Sm. Pkg.

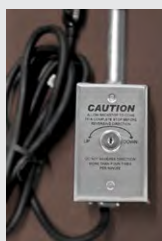

BA980EW Portable Electric Height Adjuster Wand
Operate Bison electric height adjusters effortlessly...with this 110 volt wand • One

wand with customer supplied extension cord will operate all ZipCrank or center strut height adjusters in a complete gym • Keyed switch avoids unwanted use • One-year limited warranty. Approx. shipping weight: 20#, Sm. Pkg.

BA980EW



BA975CLKS

BA975CLKS Keyless Combination Wall Switch

Eliminate the hassle of lost, broken or inconvenient keys on traditional key switch gym control systems...Three digit tumbler allows code to be changed to control unauthorized operation • Use for new construction or to easily replace existing key switches • Includes integrated molded cover plate in single gang only. Approx. shipping weight: 1#, Sm. Pkg.



BA975KS

BA975KS Key Switch

Traditional key operated switch... Up-Down labeled cover plates available in 1, 2, 3, 4 and 6 gang box options. Approx. shipping weight: 1#, Sm. Pkg.



BA955 Saf-Lok™ Structure Catch

Protect your players, fans and equipment...Saf-Lok Structure Catch insures against failure of wall, ceiling mount or batting cage structure attachment • Helps keep structure from falling to floor or into seating • Recommended in NCAA Rules Book • Provided with 3½" pipe clamps for easy installation • Works on side fold, swing-up and stationary structures including wall mount and ceiling mount • Add confidence to older structures installed prior to today's aggressive slam dunk action • Tested to 6000 lb. free-fall capacity • High strength 2" wide polyester webbing designed to take advantage of both inertial and centrifugal force • 42' effective maximum strap length • Order optional **BA955RP** retracting pulley for use on any rear braced forward fold ceiling mounted backstop • Ten-year limited warranty. Approx. shipping weight: 34#; Sm. Pk



BA925 Manual Crank Winch

Fully enclosed 1,000 lb. capacity safety worm gear winch...Cable drum is grooved for even cable wrap • Winch is furnished with crank for manual operation and wall mounting board • Comes complete with a vacuum formed cover and Saf-Arm locking device • The Saf-Arm allows the unit to be locked while not in operation and insures it is operated by authorized personnel only • Padlock not included • One-year limited warranty. Approx. shipping weight: 50#, Sm. Pkg.

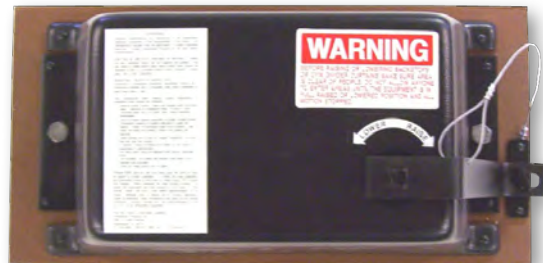

BA930 Portable 110 Volt Hand Winch Driver

Makes raising and lowering manual crank swing up structures and height adjusters faster and easier...7 AMP, ½ H.P. high torque winch • Reversible up and down operation • Two-speed motor • Includes locking device to avoid unauthorized use • To use on **BA980** series manual height adjusters order **BA935** drive shaft separately • One-year limited warranty. Approx. shipping weight: 20#; Sm. Pkg.



BA975A3 Key Operated ¾ H.P. Power Winch

Electric hoists come with the gears sealed in a gear housing and operating in grease and features a ¾ H.P. 115V single phase instant reversible motor...Unit can be wall mounted or inverted • Rotary limit switch controls the unit for both the raised and lowered positions • Worm gear winch holds load in any position • Gears are precision machined bronze alloy worm gear, induction hardened and ground steel worm • Cable drum is grooved for even cable wrap • 115V power source and 3 wires to key switch required at hoist • Includes **BA975KS** key switch and cover plate • Order **BA975A4** for same winch with 1 H.P. motor • Five-year limited warranty.

Approx. shipping weight: 105#, Sm. Pkg.





Bison Shooting Stations provide a wall mount system to match any budget and level of need. Prior to purchase, verify that your wall is suitable in construction, size and layout to support the package weight and stress from use.

Field Modifiable Wall Mounted Structure Packages

These complete kits provide all the necessary components (except wall mounting fasteners) to install a rigid, durable basketball system to the wall of your existing facility...Choose from 1'-4' or 4'-8' extensions and different backboard options shown in chart below. Cut and drill extension tubes at desired extension length • See page 17 for optional backboard padding and page 6 for optional goal height adjusters • 5-year warranty on structures • See details for warranties on backboards and goals.



PKG500

12" to 48" Safe Play Area

Package Model #	Wall to Backboard Extension Range	Backboard	Goal	Shipping Weight
PKG14STFS	12" to 48"	BA495 Fan Steel	BA34 Breakaway	Approx. weight: 225#; Truck
PKG48STFS	48" to 96"	BA495 Fan Steel	BA34 Breakaway	Approx. weight: 295#; Truck
PKG14STRG	12" to 48"	BA42XL 42" x 72" Glass	BA35S Breakaway	Approx. weight: 390#; Truck
PKG48STRG	48" to 96"	BA42XL 42" x 72" Glass	BA35S Breakaway	Approx. weight: 475#; Truck
PKG500	12" to 48"	BA407 42" x 54" Glass	BA35S Breakaway	Approx. weight: 310#; Truck

PKG650 Adjustable Height Glass Shooting Station™

Tempered glass backboard...Same heavy-duty wall structure and wall mounting boards as PKG600 below except includes 54" x 42" unbreakable side court tempered glass backboard (BA407C) for competition look and ball rebound • 36" extension at 10' rim height • Adjustable from 8' to 10' • Official size breakaway goal (BA32) with one-year limited warranty • Ten-year limited warranty on structure • **Unconditional lifetime warranty on backboard.** Approx. shipping weight 320#; Truck

PKG675 Official Adjustable Height Glass Shooting Station (not shown)

Same structure as PKG650 above but with official size 72" x 42" glass backboard and spring lift assist to make adjusting rim height easier • **Unconditional lifetime warranty on backboard.**

Approx. shipping weight: 375#; Truck

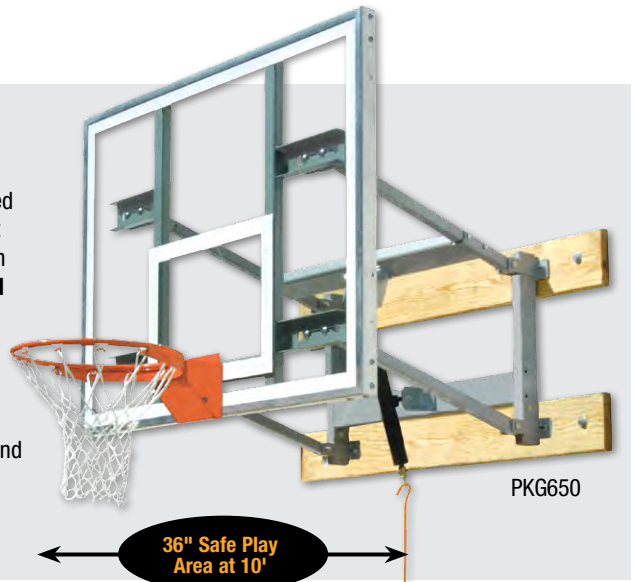

PKG650

36" Safe Play Area at 10'

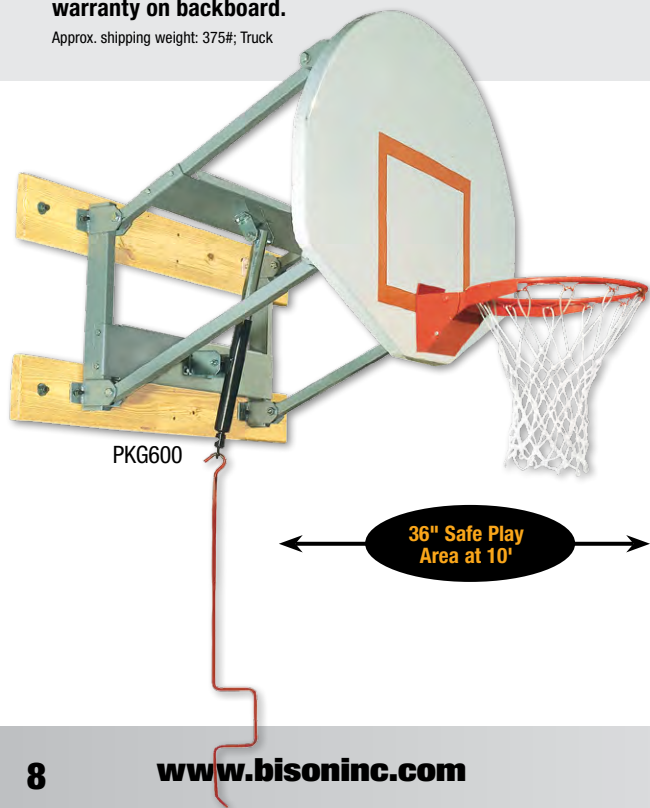

PKG600

36" Safe Play Area at 10'

PKG600 Adjustable Height Steel Shooting Station™

Convenient, cost effective system for players of all ages...All the components necessary to mount a durable, playable, institutional quality fan-shaped steel backboard and official size institutional breakaway goal to a structure that will allow goal height adjustment from 10' to 8' • Removable hand crank allows easy adjustment without ladder • Safe play area is 36" at official 10' goal height (40" at 9' and 38" at 8') • Use of 2" x 8" wall boards for load spreading wall attachment is superior to similar systems where the steel is mounted directly to the wall • All steel structure is heavy gauge tube with a 1/8" minimum wall thickness and silver powder coated finish • All pivot points are 1/2" diameter • Customer provides wall mounting hardware • Ten-year limited warranty on backboard and structure • One-year limited warranty on goal.

Approx. shipping weight: 265#; Truck

CAUTION!
Wall structure purchaser assumes mounting liability.



When traditional competition wall structures are more than your facility requires, choose from fixed height or adjustable packages with steel, glass, molded graphite or acrylic backboard options.

✓ **PKG300 ZipCrank™ Adjustable Shooting Station™**

Hand crank moves this 54" x 36" glass backboard with ease... Easy-to-operate removable hand crank adjusts goal height from official 10' to as low as 7½' for play by kids of all ages • Official size breakaway goal and direct goal mount design make backboard virtually unbreakable during normal play • Steel structure mounts to wall by means of three load spreading struts • Customer provides wall mounting anchors • Mounts indoors/outdoors • 30" safe play area at 10' • Five-year limited warranty on board and structure. Approx. shipping weight: 180#; Truck.



PKG300



PKG275

✓ **PKG275 QwikChange™ Acrylic Shooting Station™**

For the look of a professional court at a budget price... Official size flex goal raises and lowers with ease on this system that features a 32" x 48" clear rectangular backboard • Direct mount goal design • No ladders or tools • 7½' to 10' goal height adjusts from the playing surface • Entire system mounts easily to the wall with two load spreading struts • Customer supplies suitable wall mounting hardware • Mounts indoors/outdoors • 22" safe play area at 10' • One-year limited warranty on system.

Approx. shipping weight: 105#; Sm. Pkg. Ships Oversize



PKG250

✓ **PKG250 QwikChange™ Graphite Shooting Station™**

Our lowest cost adjustable wall mount system... Move the goal height from 7½' to 10' in 6" increments with a broom handle from the floor • 36" x 48" molded graphite fan-shaped backboard and official size flex goal are direct mounted to the steel structure for superior backboard durability • QwikChange structure is attached to wall with two struts to spread load on wall • Customer provides wall mounting anchors • Mount indoors/outdoors • 22" safe play area at 10' • One-year limited warranty on system. Approx. shipping weight: 90#; Sm. Pkg. Ships Oversize

CAUTION!

Wall structure purchaser assumes mounting liability.



Select the Bison T-Rex™ portable that best fits your program's needs.

T-Rex™ Portable Basketball Systems

T-Rex design incorporates low maintenance, extension spring technology and heavy-duty structural components to make one-person set up and storage easy and fast. This is the same spring technology used almost exclusively in collegiate Division I and professional arenas. All pivot points have zero maintenance, self-lubricating bearings and large diameter pivot pins for smooth up-and-down operation and superior system rigidity. The entire base is padded on front and sides with 2" thick urethane foam covered in your choice of 16 colors. Safety is insured with factory installed hidden ballast inside the base to prevent tipping. Floor hold downs as required by NCAA and National High School Federation rules are standard on T-Rex 96 and optional on other T-Rex systems. Each T-Rex model rolls on high capacity, floor-friendly 8" diameter, 2" wide running gears for easy transport. When unit is in place, just drop locator pins into floor bushings for exact placement and lower the front stabilizer pads with an easy-to-reach ratcheting foot adjustment system.

Competition T-Rex 96

180° Competition Breakaway Goal

Lifetime Warranty on Glass Backboard

Direct Mount Design for Backboard Stability

Original DuraSkin® Backboard Padding

96" Safe Play Area at 10'

16 Padding Color Choices

Optional Padding Lettering

THUNDER

Optional Oversized LOGO

Deadlock Tensioning Device

Folds for Storage

Front Foot Leveling

BA898G T-Rex™ 96 Competition

Competition portable...T-Rex 96 features official 42" x 72" unbreakable competition glass backboard, latest technology 180° breakaway goal and a full 96" of safe play area from backboard to base as specified by the NCAA and National High School Federation

- **New deadlock tensioning device adds even greater system rigidity**
- Additional standard features include padding for underside of beam, rear hold down kit, supplemental beam support and double rear caster running gear
- Choose from colors of backboard and base padding shown on page 102.

BA898HD Rear Hold-Down Kit

For all T-Rex portables...Meets NCAA and High School Federation rules requiring rear floor attachment for competition portable goals

- Kit includes threaded floor anchor, eyebolt and turnbuckle to attach to built-in eye on rear of T-Rex 54 JR, T-Rex 54 SR, T-Rex 66 and T-Rex 96
- Included standard with T-Rex 96
- Adds a measure of stability and safety
- One required per goal. Approx. shipping weight: 3#; Sm. Pkg.



SCBKT2 Folding Shot Clock Bracket

This sturdy bracket is specifically designed to allow installation of beam mounted shot clock brackets on T-Rex portables

- Folds to the rear to allow passage through doorways and halls when T-Rex is collapsed for storage in off season.
- Approx. shipping weight 89#, Sm. Pkg.



BA898GDL Optional Deadlock Tensioning Device

Add stability to BA895G T-Rex Portables with the inclusion of this optional feature

- One required per goal
- Standard feature on BA898G portable. Approx. shipping weight: 5#/each; Sm. Pkg.



Forklift or dock required for delivery. Contact Bison for other off-loading options.



BA898G-RY Shown with Optional ABC52 Lettering and ABC50 Logo





BA895G T-Rex™ 66 Side Court

For the side court...T-Rex 66 is made for programs where space constraints do not allow a full 96" official extension but program still wants an official size backboard and all the quality features of more expensive spring technology portables • T-Rex 66 includes a 42" x 72" unbreakable competition glass backboard, durable competition break-away goal and 66" safe play area • Choose from colors for backboard and base padding shown on page 102.

ABC50 Oversized One- or Two-Color Logo

Available on bases of all T-Rex portable basketball systems and Arena volleyball system...Send your logo to the Bison Art Department prior to placing order to confirm reproduction suitability • Artwork subject to pre-approval and hourly BNART artwork charges may apply • Select from colors shown on page 102.

BA895G-SC Shown with Optional ABC52 Lettering and ABC50 Logo



BA894GSR T-Rex™ 54 SR Club

When space or resources are at a premium but official 72" size glass backboards are a must...T-Rex 54 SR is the perfect balance • What this system lacks in size, it makes up for in playability • Full 54" of safe play area allows the base to be 6" outside the end line of an official court • Get all the basic features of our larger T-Rex portables on a compact base that fits in gyms where others won't • T-Rex 54 SR is completely padded on base and has the same breakaway goal and DuraSkin backboard padding as T-Rex 66 • See page 102 for color options.

BA894GSR Shown with Optional ABC52 Lettering



BA894GJR T-Rex™ 54 JR Recreational

Small but mighty...T-Rex 54 JR is identical to T-Rex 54 SR but has a downsized 42" x 54" glass backboard for easier transport and storage • Includes 54" DuraSkin backboard padding available in your choice of gray or black • See page 102 for color options • With a 54" wide backboard, T-Rex 54 JR fits through doors or hallways as narrow as 58" wide for the most compact storage and transport of our T-Rex lineup.

BA894GJR Shown with Optional ABC52 Lettering



One-Person Set Up and Easy Height Adjustment

	Competition BA898G T-Rex 96	Side Court BA895G T-Rex 66	Club BA894GSR T-Rex 54 SR	Recreational BA894GJR T-Rex 54 JR
Backboard Size	42" x 72"	42" x 72"	42" x 72"	42" x 54"
Backboard Type	Glass	Glass	Glass	Glass
Goal Type	BA3180S	BA35S	BA35S	BA35S
Total System Weight with Ballast	2350#	1900#	1700#	1550#
Ballast Weight	1000#	800#	950#	800#
Padded Base Size	40" (w) x 74" (l)	40" (w) x 74" (l)	40" (w) x 65" (l)	40" (w) x 65" (l)
Total Stored Dimensions	76" (w) x 160" (l) x 78" (h)	76" (w) x 130" (l) x 78" (h)	76" (w) x 124" (l) x 78" (h)	56" (w) x 124" (l) x 78" (h)
Setback at	10' - 96" 9' - 53" 8' - 42"	10' - 66" 9' - 23" 8' - 12"	10' - 54" 9' - 14" 8' - 0"	10' - 54" 9' - 14" 8' - 0"
Lowest Playing Height	7'	7'	8'	8'
Rear Hold-Down Kit	Included	Optional	Optional	Optional
Floor Load/Wheel Transport Weight	450# Front 725# Rear	350# Front 600# Rear	N/A	N/A
Floor Load/Wheel Playing Weight	700# Front 475# Rear	575# Front 375# Rear	N/A	N/A
Min. Required Floor Space Outside End Line	130"	100"	72"	72"
Shipping Weight	2625# Truck	2150# Truck	1925# Truck	1725# Truck

Warranties

Portable Structures	Ten-Year Limited	Ten-Year Limited	Ten-Year Limited	Ten-Year Limited
Backboards	Lifetime Limited	Lifetime Limited	Lifetime Limited	Lifetime Limited
Backboard Padding	Ten-Year Replacement	Ten-Year Replacement	Ten-Year Replacement	Five-Year Limited
Goal	Three-Year Limited	Unconditional Three-Year	Unconditional Three-Year	Unconditional Three-Year
Wheels, Foot Pads, Springs	Five-Year Limited	Five-Year Limited	Five-Year Limited	Five-Year Limited

Forklift or dock required for delivery. Contact Bison for other off-loading options.



Max™ Portable Basketball Systems

Maximum versatility, maximum safety, maximum playability and maximum value......makes one of our Max portable systems just right for your facility • Choose Super Max with 60" tempered glass backboard and 50" safe play area, Glass Max with 54" tempered glass backboard and 30" safe play area or Acrylic Max™ with 48" acrylic backboard and 30" safe play area.

No matter which Max you choose, you'll get features not found on similar systems offered by other manufacturers including:

- Infinite Goal Height Adjustment from 5' to Official 10'
- Durable Breakaway Goals
- Full Front Base and Pole Padding in Your Choice of Black, Royal, Scarlet or Forest Green. Additional colors offered on orders of two or more, see page 102.
- Over 850# of Hidden, Customer Supplied Ballast to Eliminate Tip Over Risk (see BA853BLST below)
- Ballast is Totally Enclosed and Safety Padded
- Single-Lever Lift Handle to Allow Easy Transport and Set Up
- Goal Mounts Through Backboard Directly to Structure to Eliminate Backboard Stress
- Non Marking Transport Wheels
- When Lowered, Fits through 78" High Double Doors for Storage
- Standard Backboard Edge Padding on Super Max and Glass Max (optional on Acrylic Max)

Great Play at a Great PRICE



Infinite Height Adjustment



Padded Weight Box Cover

Special liftgate delivery charge or extreme manual lifting required if dock/forklift not available.



BA853BLST Max™ Ballast Kit

Twenty-five 4" x 8" x 16" solid concrete cap blocks to properly eliminate tip over on all Max portable goals. Approx. shipping weight: 850#; Truck

WARNING!
All Max systems require installation of 25 4" x 8" x 16" solid concrete cap blocks prior to use. The ballast tray and padded safety cover are designed specifically for use of the specified ballast. Failure to install the specified weight could result in serious player injury and invalidate all warranties. While the specified blocks are available at most lumber or home centers for a nominal cost, Bison can ship ballast package BA853BLST for an additional cost.

	BA853GXL Super Max	BA853G Glass Max	BA853A Acrylic Max
Backboard Size	36" x 60"	36" x 54"	32" x 48"
Backboard Type	Glass	Glass	Acrylic
Goal Type	BA32	BA32	BA29JR
Backboard Padding	Standard	Standard	Optional
Total System Weight (with ballast)	1550#	1450#	1400#
Customer Supplied Ballast Weight	850#	850#	850#
Padded Base Size	42" (w) x 50" (l)	42" (w) x 50" (l)	42" (w) x 50" (l)
Total Stored Dimensions	64" (w) x 139" (l) x 78" (h)	58" (w) x 128" (l) x 78" (h)	48" (w) x 128" (l) x 78" (h)
Setback at	10' - 50" 9' - 60" 8' - 68"	10' - 30" 9' - 40" 8' - 48"	10' - 30" 9' - 40" 8' - 48"
Lowest Playing Height	5'	5'	5'
Min. Required Floor Space Outside End Line	54"	N/A	N/A
Approx. Shipping Weight	800#	700#	640#
Warranties			
Base	Five-Year Limited	Five-Year Limited	Five-Year Limited
Padding	Two-Year Limited	Two-Year Limited	Two-Year Limited
Goal	One-Year Limited	One-Year Limited	One-Year Limited
Backboard	Ten-Year Limited	Ten-Year Limited	Two-Year Limited

Portable Rear Hold-Down Kits

Additional stability...Add stability to any Bison Max portable system with these floor anchors and brackets.



BA800 For Concrete, Tile or Synthetic Floors

Kit includes two each of VB25 floor anchors and brackets...Requires core drilling into existing floors. Approx. shipping weight: 15#; Sm. Pkg.

BA800FL For Floating Wood Floors

Kit includes two each of VB25FL floor anchors and brackets for floating floors...Requires core drilling and routing into existing floors. Approx. shipping weight: 17#; Sm. Pkg.





Club Court™ Portable Basketball Systems

Choose **Super Glass Club Court** with 54" tempered glass backboard and 48" safe play area, **Glass Club Court** with 54" tempered glass backboard and 30" safe play area. **Acrylic Club Court** with 48" clear acrylic backboard and 36" safe play area or **Graphite Club Court** with 48" molded graphite fan backboard and 36" safe play area.

All four Club Court portables come standard with the following features:

- Spring Assisted Infinite Goal Height Adjustment from 6½' to Official 10'
- 1½" Thick, Black Padded Front Base and Riser
- Easy Flip Down Front Panel for Transport
- Fully Enclosed Oversized Ballast Enclosure to Hold Customer Supplied Ballast (see chart and BA833BLST below)
- Goal Mounts Directly to Extension Arm, Eliminating Stress on Backboard During Play
- Easily Folds Without Tools for Movement Through 78" High Double Doors
- Order ABC52 for Optional Front Pad Lettering
- Easy-to-Read Goal Height Indicator Labels
- Non Marking Transport Casters

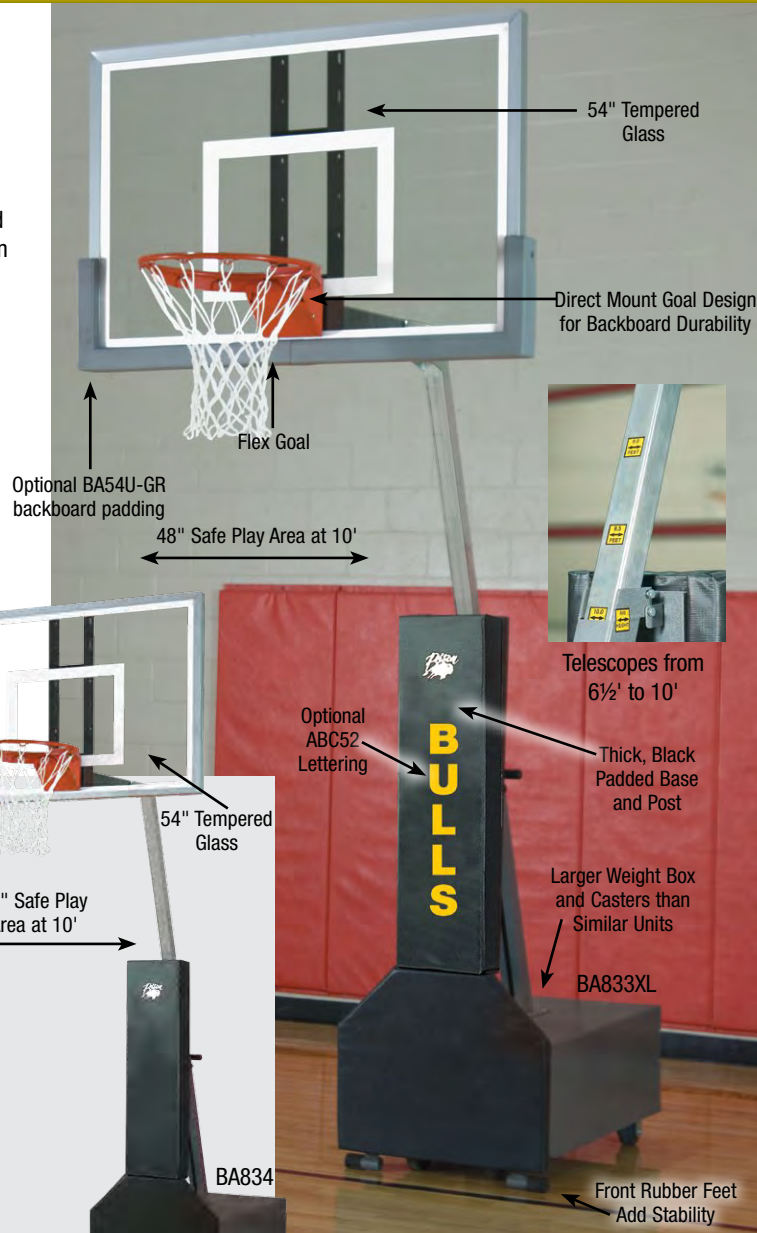
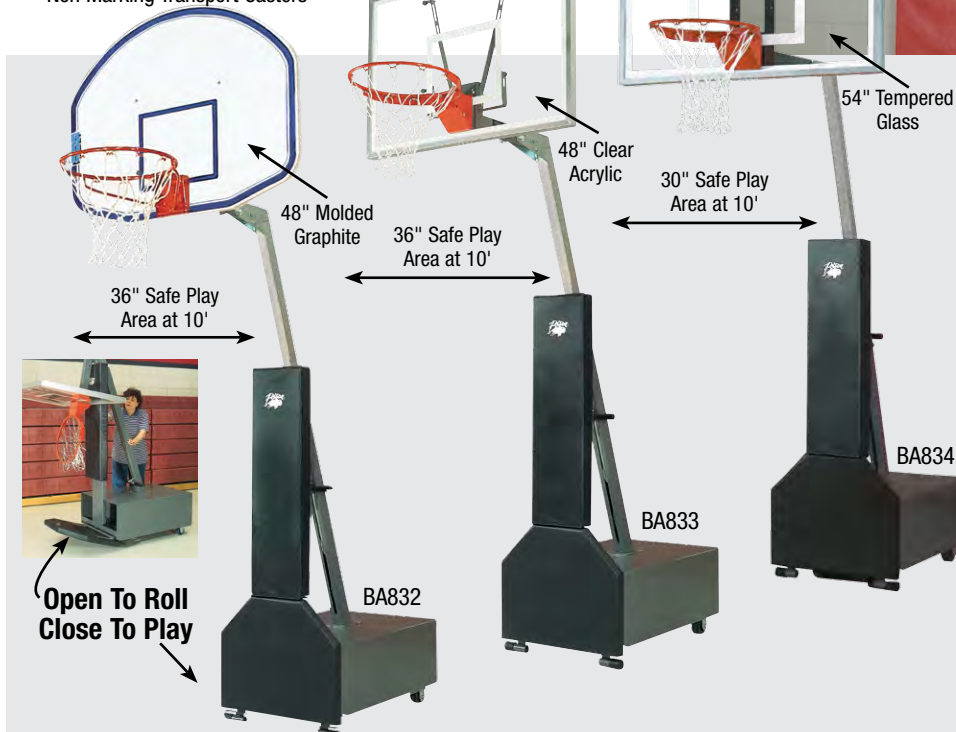

Special liftgate delivery charge or extreme manual lifting required if dock/forklift not available.

BA833BLST Club Court Ballast Kit

Approximately 425# of solid concrete cap blocks to properly eliminate tip over on all Club Court portable goals. Order one BA833BLST for each BA832, BA833 and BA834 • Order two for each BA833XL.

Approx. shipping weight: 450#, Truck

WARNING!
Club Court portables are designed for customer installation of solid concrete cap blocks prior to use. Failure to install the specified ballast could result in serious player injury and invalidation of all warranties. While specified blocks are available at most lumber or home centers for a nominal cost, Bison can ship ballast package BA833BLST for an additional cost.

	BA833XL Super Glass	BA834 Glass	BA833 Acrylic	BA832 Graphite
Backboard Size	36" x 54" Rectangle	36" x 54" Rectangle	32" x 48" Rectangle	36" x 48" Fan
Backboard Type	Glass	Glass	Acrylic	Molded Graphite
Goal Type	BA32	BA32	BA29JR	BA26
Total System Weight (with ballast)	1400#	1000#	855#	840#
Customer Supplied Ballast Weight	850#	425#	425#	425#
Padded Base Size	34" (w) x 46" (l)	29" (w) x 41" (l)	29" (w) x 41" (l)	29" (w) x 41" (l)
Total Stored Dimensions	54" (w) x 84" (l) x 78" (h)	54" (w) x 78" (l) x 78" (h)	48" (w) x 78" (l) x 78" (h)	48" (w) x 78" (l) x 78" (h)
Setback at	10' - 48" 9' - 44" 8' - 40"	10' - 30" 9' - 26" 8' - 22"	10' - 36" 9' - 32" 8' - 28"	10' - 36" 9' - 32" 8' - 28"
Lowest Playing Height	6½'	6½'	6½'	6½'
Warranty				
Entire System	One-Year Limited	One-Year Limited	One-Year Limited	One-Year Limited





Playtime™ Elementary Portables

Playtime complete basketball standards roll in and out of the gym or multipurpose room with ease...Formed steel base provides sturdy foundation for tubular structure

- Telescoping structure easily adjusts goal height from 8' to 6½' in 6" increments
- White powder coated finish
- Choose 36" x 48" fan-shaped backboard of molded graphite or 32" x 48" rectangular backboard of clear acrylic
- Official size, 5/8" solid steel goal
- Playtime systems are for physical education, elementary school or shooting practice only and are not intended for aggressive competitive play
- **Safe Stuff structure padding included**
- Lower base trim protects your floor from damage
- Some assembly required
- Factory installed 100# ballast hidden in base. Approx. shipping weight: 330#; Truck



Special liftgate delivery charge or extreme manual lifting required if dock/forklift not available.



Playtime	BA803	BA803A
Backboard Size	36" x 48"	32" x 48"
Backboard Type	Molded Graphite	Clear Acrylic
Goal Type	BA26	BA26
Total System Weight (with ballast)	330#	350#
Ballast Weight	Built-in	Built-in
Total Stored Dimensions	48" x 48" x 84"	48" x 48" x 84"
Lowest Playing Height	6½'	6½'
Warranty		
Entire System	One-Year Limited	One-Year Limited

PORTABLE GAME BASES AND ACCESSORIES

PB130, PB180, PB220 Portable Game Bases



Indoors or outdoors, these portable weighted bases support a wide range of PE games... Use for volleyball, badminton, pickle ball, tennis, tetherball, paddle tennis, hoop games, jump rope or other creative games • 24" diameter royal blue powder coated bases are factory weighted in your choice of 130# (PB130), 180# (PB180) or 220# (PB220) • Durable non-marking wheels and molded urethane bottom ring protect floors during transport and use • Includes 1¼" diameter x 10' galvanized steel upright

- Order nets, base padding and other accessories separately
- Includes one pair of PB150C1 game attachment collars • One year limited warranty.

Approx. shipping weight: 200#, 250#, 300#, Truck



SVB08 Volleyball Net
Official 32' x 36" size with fluorescent top tape for maximum visibility.

Approx. shipping weight: 3#; Sm. Pkg.



BM10N Badminton Net
Official 21' x 30" size.

Approx. shipping weight: 4#; Sm. Pkg.



TB300 Tetherball
See page 64



PB150C Game Attachment Collars

Use to attach nets, tetherball rope or any game accessory to the 1¼" diameter pole on PB130, PB180 or PB220 portable game bases • Order **PB150C1** for single loop, **PB150C2** for double loop and **PB150C4** for 4 loop collars • Sold in pairs. Approx. shipping weight 5#/pr.

PB100BP Base Padding

Improve safety with this specially designed pad that covers 360° around the PB130, PB180 and PB220 portable game bases...1" thick foam with sewn cover in black vinyl • Velcro attachment. Approx. shipping weight: #10; Sm. Pkg.



PB150BB Basketball Accessory

Easy slip-on ring creates a goal for elementary shooting games...15" diameter ring with net hooks • Adjusts to any height for thumbscrew tightening • Ring and net only, order base with pole separately. Approx. shipping weight: 10#; Sm. Pkg.





DN1250

Clip-On Net Hold Down Weights

Base Shown with SVB08 for PE Net Games



DN12

DN1250 Portable **Divider Net System**

Separate courts for safe play without expensive ceiling mounted divider curtains...12' high, 50' long black mesh net has durable reinforced vinyl edges and stores in a zippered storage bag when not in use • Net is supported by two factory weighted bases with telescoping poles for easy set up and storage • So versatile it can be used in any indoor or outdoor location • Portable bases and posts can also be used for P.E. net games at any height, including volleyball, badminton and tennis with purchase of SVB08 recreational volleyball net • Extend the divider net in 50' increments with purchase of additional DN12 bases and DN50 nets. Approx. shipping weight: 750#; Truck

DN12 **Divider Net System Adder Base**

Extend divider net...Add bases and nets • Same weighted base and 12' telescoping net support pole as DN1250 system above. Approx. shipping weight: 310#; Truck



DN50

DN50 **12' x 50' Divider Net**

Add additional nets. . .Extend divider system • Includes zippered storage bag and pole attachment hardware. Approx. shipping weight: 25#/each; Sm. Pkg.



BA801BP **Portable Base Padding**

Improve player safety...Specially designed pad that covers 360° around the divider net base • 1" thick foam with black vinyl sewn cover • Velcro attachment. Approx. shipping weight: 10#; Sm. Pkg.

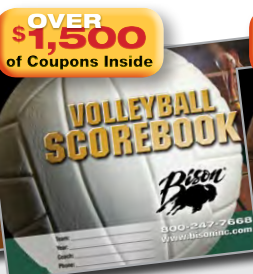
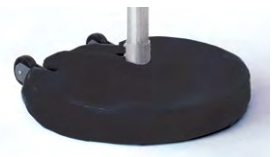

**Factory Rebate
Coupons Inside
Each Scorebook**

See back cover for details.





Gym Upgrade Packages

When it's time to upgrade your basketball court, Bison's Official Gym Upgrade Packages will save you money and guarantee single source compatibility...

There is a package to fit your existing wall or ceiling mount structure regardless of manufacturer

• All components are designed and built by Bison for guaranteed compatibility

• Premium and standard upgrade packages available, all with backboard, goal and backboard padding

• All packages contain one of each of the listed Bison basketball components

• Order two packages to upgrade both ends of the court.



OFC4234-RY

BUY IN PACKAGES & SAVE!

Package Description	Backboard		Goal		Padding			Shipping
	Model/Size	Warranty	Model	Warranty	Model	Warranty	Color	
V OFX423180-XX Official Premium 180° Short Board Upgrade Package	BA42XL 42" x 72"	Unconditional Lifetime	BA3180S	Four-Year Limited	BA68U	Ten-Year Replacement	17 Colors Please Specify	295# Truck
V OFX4235E-XX Official Premium Short Board Upgrade Package	BA42XL 42" x 72"	Unconditional Lifetime	BA35S	Three-Year Limited	BA68U	Ten-Year Replacement	17 Colors Please Specify	237# Truck
V OFS4234-XX Official Standard Short Board Upgrade Package	BA42E 42" x 72"	Ten-Year Limited	BA34	One-Year Limited	BA68U	Ten-Year Replacement	17 Colors Please Specify	210# Truck
V OFC4235E-XX Official Premium Conversion Board Upgrade Package	BA42XLC 42" x 72" Conversion	Unconditional Lifetime	BA35S	Three-Year Limited	BA68U	Ten-Year Replacement	17 Colors Please Specify	254# Truck
V OFC4234-XX Official Standard Conversion Board Upgrade Package	BA42XLC 42" x 72" Conversion	Unconditional Lifetime	BA34	One-Year Limited	BA68U	Ten-Year Replacement	17 Colors Please Specify	250# Truck
V OFX483180-XX Official Premium 180° Tall Board Upgrade Package	BA48XL 48" x 72"	Unconditional Lifetime	BA3180T	Two-Year Limited	BA68U	Ten-Year Replacement	17 Colors Please Specify	285# Truck
V OFX4835E-XX Official Premium Tall Board Upgrade Package	BA48XL 48" x 72"	Unconditional Lifetime	BA35	Three-Year Limited	BA68U	Ten-Year Replacement	17 Colors Please Specify	275# Truck
V OFS4834-XX Official Standard Tall Board Upgrade Package	BA48 48" x 72"	Ten-Year Limited	BA34	One-Year Limited	BA68U	Ten-Year Replacement	17 Colors Please Specify	240# Truck



Center Strut Backboard and Height Adjuster Adapters

If your existing center strut ceiling mount structure is not designed to mount to backboard corners...these adapters allow installation of Bison backboards and/or ZipCrank height adjusters to your existing center strut structures • **Caution!** May reposition face of backboard in relationship to court lines • Select from the chart below. Approx. shipping weight: 50#/pair; Sm. Pkg.

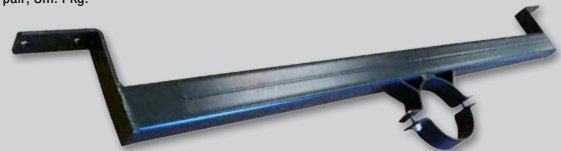

Model #	Center Strut Diameter	Backboard Mounting Pattern	Shipping Weight
BA600YF	6"	35" (w) x 20" (h) (fan)	Approx. weight: 50#/pair; Sm. Pkg.
BA600YR	6"	62" (w) x 36" (h) or 62" (w) x 42" (h)	Approx. weight: 75#/pair; Sm. Pkg.
BA658YF	6 5/8"	35" (w) x 20" (h) (fan)	Approx. weight: 50#/pair; Sm. Pkg.
BA658YR	6 5/8"	62" (w) x 36" (h) or 62" (w) x 42" (h)	Approx. weight: 75#/pair; Sm. Pkg.



OFTEN IMITATED – NEVER EQUALED

10-YEAR
Replacement Warranty

BISON'S ORIGINAL
DURASKIN

THE GAME'S MOST POPULAR BACKBOARD PADDING

v **BA68U DuraSkin®** Backboard Safety Padding

The first, the best and now available in a virtual rainbow of colors.

- Pin-Style Center Pad Connectors
- Slimmer Cross Section for Reduced Rebound Interference
- **Now with a 10-Year Replacement Warranty**



Compare to copycat padding with fewer colors and shorter five-year warranties, inferior below the rim padding connectors and frustrating pad trimming...DuraSkin meets or exceeds all NCAA, FIBA and National High School Federation requirements • Fits every manufacturers' official 72" wide glass backboard but might require frame drilling on some non-Bison backboards • All Bison glass backboards are predrilled for five-minute installation of DuraSkin with only a screwdriver • Far superior to glue-on, vinyl dipped or other safety padding systems • One kit protects one backboard, order two kits per court • Includes mounting hardware • **Compare our 10-year replacement warranty to other manufacturers' 5-year warranties.** Approx. shipping weight: 12#/kit; Sm. Pkg. Ships Oversize

Available in 17 School Colors

Model Number	Color
BA68U-BK	Black
BA68U-KL	Kelly Green
BA68U-SC	Scarlet
BA68U-RY	Royal
BA68U-OR	Orange
BA68U-FG	Forest Green
BA68U-CL	Columbia Blue
BA68U-MR	Maroon
BA68U-GL	Gold
BA68U-GR	Gray
BA68U-PR	Purple
BA68U-NY	Navy
BA68U-VG	Vegas Gold
BA68U-CD	Cardinal
BA68U-BR	Brown
BA68U-BO	Burnt Orange
BA68U-PK	Pink

Colors are not guaranteed to match catalog samples.

BA68F DuraSkin® for Fan-Shaped Backboards

Fits all front mount or rear mount glass or steel fan backboards...DuraSkin quality and safety for fan-shaped backboards • Bolt-on dependability • Fits all official size 54" wide x 35"-39" tall rear and front mount backboards • Mounts to steel, glass and cast aluminum backboards • Available in gray or black • Molded-in steel attachment inserts • Slim profile to reduce potential for ball interference • Requires drilling • Includes mounting hardware and instructions • Priced per kit but packaged two kits per carton • One kit covers one backboard • **One-year limited warranty** (indoors only). Approx. shipping weight: 5#/kit; Sm. Pkg.



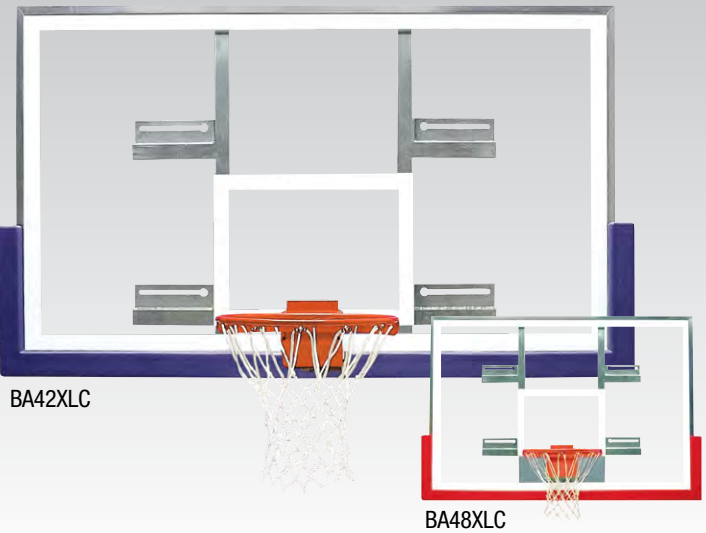

Rear Stabilizer Bar Eliminates Stress on Glass

Unbreakable "XL" Glass Backboards

Built-in support structure absorbs over 98% of the stress from goal contact without transferring it to the glass... Goal is mounted "off glass" so even excessive hanging and abuse will not cause stress • Never again be concerned about the risk of injury or inconvenience of glass breakage • We are so confident of our "XL" design durability that for over five years we have offered a **\$250** installation reimbursement in addition to our **unconditional replacement warranty** without a single request for reimbursement • Every "XL" unbreakable backboard features a polished aluminum extrusion framework, glass cushioning gasket, high strength steel support structure, ½" tempered glass with fire impregnated bright white border and shooters square and **unconditional lifetime warranty** • All Bison glass backboards on this page are predrilled for quick installation of original DuraSkin backboard padding.

V BA42XL 42" Short Unbreakable "XL" Glass Backboard

The 42" x 72" short board version of our "XL" backboard line...This backboard has the industry standard 35½" x 62" structure mounting design and 5" x 4" goal hole pattern to make upgrade retrofitting to any manufacturer's short board ceiling or wall mount structure foolproof

• **Unconditional lifetime warranty.** Approx. shipping weight: 200#; Truck

V BA48XL 48" Tall Unbreakable "XL" Glass Backboard

Same as BA42XL except 48" x 72" size...With 42" x 62" structure mounting pattern and 5" x 5" goal mounting pattern • Compatible with all manufacturer's tall board structures • BA48XL is the only unbreakable 48" backboard in the industry and is the perfect solution to upgrading old traditional 48" glass boards that are now in use in thousands of gyms across the country • **Unconditional lifetime warranty.** Approx. shipping weight: 240#; Truck

V BA42E Standard 42" Short Backboard (not shown)

Excellent value • Meets or exceeds all NCAA and National High School Federation rules • Predrilled for original DuraSkin backboard padding • 42" x 72" x ½" tempered glass with fire impregnated, bright white border and shooters square • Polished aluminum framework • 36" x 62" structure and 5" x 4" rim mounting pattern • 10-year limited warranty. Approx. shipping weight: 180#; Truck

V BA48 Standard 48" Tall Backboard (not shown)

Traditional size, improved quality • This 48" x 72" board is a common fixture in gyms across the US and meets all appropriate rules for competition play • Board features 42" x 72" structure and 5" x 5" goal mounting pattern and will replace virtually any manufacturer's original tall glass backboard • 10-year limited warranty. Approx. shipping weight: 210#; Truck

V BA42XLC 42" Short Unbreakable "XL" Glass Conversion Backboard

Make the transition...Go from old fan-shaped steel or glass backboards to popular 42" x 72" rectangular glass backboards normally without modification or relocation of your existing wall or ceiling support structures

• The 35" wide x 20" high rear structure mounting pattern is the standard in the industry for most fan-shaped gym backboards and structures

• **Unconditional lifetime warranty.** Approx. shipping weight: 220#; Truck

BA48XLC 48" Tall Unbreakable "XL" Glass Conversion Backboard

This board is intended primarily for replacement of broken, existing 48" boards, mounted on fan style, wall or ceiling structures (35" x 20") common in older gyms...If you are replacing fan steel or glass backboards on both ends of a court, Bison recommends use of BA42XLC short backboards • Consult a Bison Product Specialist for selection of the right board for your application • Formerly BA48C

• **Unconditional lifetime warranty.** Approx. shipping weight: 240#; Truck

Bison is confident you will never need to replace these boards – so confident that we offer a \$250 installation reimbursement for any broken BA42XL, BA42XLC, BA48XL or BA48XLC backboard replaced under Bison's lifetime warranty!

CAUTION!
Studies have demonstrated that 42" x 72" glass backboards reduce the risk of player injury from backboard contact. BA42XL and BA42XLC are recommended for all new installations and fan-to-rectangle conversions. Bison makes 48" x 72" backboards (BA48, BA48XL and BA48C) available ONLY for replacement applications.



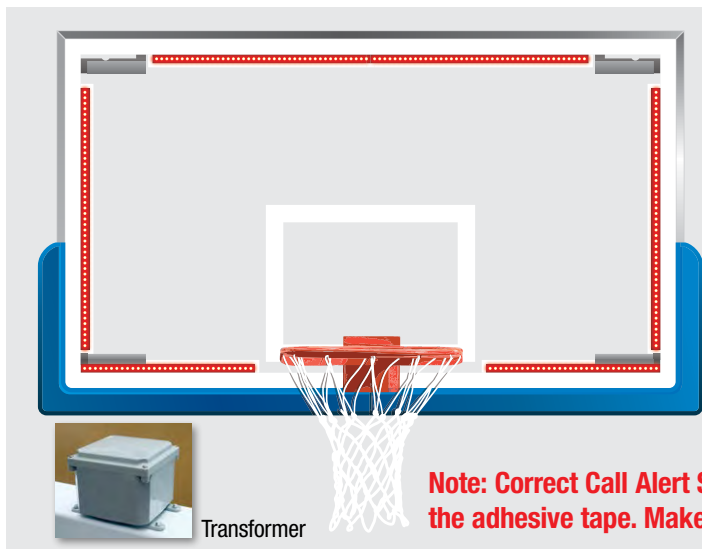

BALED Correct Call™ LED Backboard Alert Systems

Popular at the collegiate level... LED Alert Systems are coming soon to a high school near you • Bison LED system is easy to install behind virtually any manufacturer's glass backboard (42" or 48" high) with no drilling and no visual hardware • Will interface with virtually any scoreboard system that is capable of sending a signal from the official scoreboard time clock or shot clock to this 12 volt LED system • Six separate preassembled LED light strips are mounted in aluminum tracks with high tack, self adhesive mounting tape system for quick and easy installation • System includes LED strips for one backboard, transformer and all necessary components except the wiring that is required to run from the scoreboard signal location to the transformer box • Call a Bison Customer Service Specialist for details • Five-year limited warranty. Approx. shipping weight: 10#; Sm. Pkg.

Note: Correct Call Alert Systems are not returnable once backing is removed from the adhesive tape. Make sure your LED strips are compatible with your backboard.



BA407C Side Court Conversion Glass

The most affordable glass option available... This backboard is identical to our full-sized, official conversion backboard (BA42XLC) except its 42" x 54" size makes it the most affordable glass option for side courts, recreation centers or other applications where cost is a serious consideration • Play is identical except board has 9" per side less glass to hit

on errant shot • ½" tempered glass • Simply remove an existing fan board and bolt up this board for a low cost conversion from steel fan to rectangular glass • **Unconditional lifetime warranty.** Approx. shipping weight: 175#; Truck



BA455 42" x 72" Tuffglass™ Rectangular

High gloss bright white gel-coat finish with permanent molded-in orange shooter's square and border... Solid fiber laminate core • Popular

42" x 72" competition size • 1⁵/₁₆" thick • 5" x 4" goal mounting pattern • Threaded steel inserts are molded into the back of the board to provide a means of mounting to fan or rectangular wall structures or pole system braces • Provides the quality rebound desired by quality players • Ten-year limited warranty. Approx. shipping weight: 160#; Truck



BA407G Unbreakable Glass Side Court

A scaled down version of our popular unbreakable 42" x 72" competition glass backboard...

Reduced to 42" x 54" to reduce weight and cost without sacrificing features • Goal is mounted "off glass" so even excessive hanging will not cause stress • Order Bison PKG500 to mount this board between 12" and 48" from the wall • **Unconditional lifetime warranty.** Approx. shipping weight: 150#; Truck



BA465 Tuffglass™ Fan-Shaped

High gloss, bright white gel-coat finish... Molded-in permanent orange border and shooter's square • Solid fiber laminate core • Official 39" x 54" size, 1⁵/₁₆" total thickness • Completely weatherproof for outdoor

or indoor use in all climates • 5" x 5" hole pattern • Threaded insets are molded into the backboard to allow mounting to common fan-shaped structures (20" x 35") and most outdoor playground poles. Ten-year limited warranty. Approx. shipping weight: 89#; Truck



BA44XL Extended Life Competition Fan-Shaped Glass

Unbeatable warranty because this is a better built fan-shaped glass backboard... Built-in support strut greatly improves durability • Official size 39" x 54" • Cushioned ½" tempered glass • Heavy-duty aluminum framework • Fire-impregnated white border and shooter's square • Industry standard

20" x 35" mounting brackets • Order BA68F padding separately • **Unconditional lifetime warranty.** Approx. shipping weight: 115#; Truck



BA495 Dura Steel™ Fan-Shaped

Steel, and lots of it, highlight this 39" x 54" official size backboard... Great option to replace rear mount side court backboards for greater durability • 12 ga. skin • Heavy-duty

mounting support structure • 5" x 5" hole pattern • Standard 20" x 35" fan-type backboard mounting holes • Superior front mount design • Heaviest backboard of its type • White powder coated finish • Official orange shooter's square • Ten-year limited warranty.

Approx. shipping weight: 100#; Truck



See page 103 to send your photo/video to Bison





Baseline™ 180° Breakaway Goal

The **ONLY** true 180° Breakaway Goal with a Positive Lock Release Mechanism!

From the left baseline, right baseline, down the lane or any angle in between, Baseline will provide consistent breakaway pressure even during the most aggressive slam dunk action... This is the most technologically advanced breakaway goal available today with the ring assembly floating on 13 hardened chromium steel ball bearings for smooth flexibility from any direction • Pressure release mechanism is field adjustable to insure the preferred feel and adherence to NCAA ring testing rule for the life of the goal • Meets National High School Federation and NCAA standards • Includes anti-whip net and mounting hardware.

BA3180S Baseline™ Collegiate 180°

For 42" x 72" backboards... The preferred goal to use on all short 42" glass backboards at any level of play • **Four-year repair or replacement warranty.** Approx. shipping weight: 39# each; Sm. Pkg.

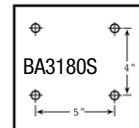

BA3180T Baseline™ Universal Prep 180°

Universal board mounting design... Same mechanism as Collegiate above but fits both 48" x 72" and 42" x 72" glass boards • Use at all levels of play • **Two-year repair or replacement warranty.** Approx. shipping weight: 39# each; Sm. Pkg.

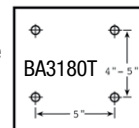

Meets **NCAA Rule** regarding rebound elasticity

BA35A ReAction™ Breakaway Goal

Hideaway net attachment system makes net system failure virtually impossible and greatly improves player safety... Net attachment cable easily passes through the tubular channel in seconds without use of tools • AcuFlex™ adjustable, positive lock breakaway mechanism allows fine tuning throughout the life of the goal with special tool provided • Increased flexibility provides greater energy absorption • Steel coverplate • 5/8" diameter, high tensile steel ring with 1/4" full Oradius rim support • Fits all makes and models of glass backboards both 42" and 48" high • Meets National High School Federation and NCAA standards • Includes mounting hardware and anti-whip net • **Four-year limited warranty.**

Approx. shipping weight: 23# each; Sm. Pkg.

4-YEAR Replacement Warranty

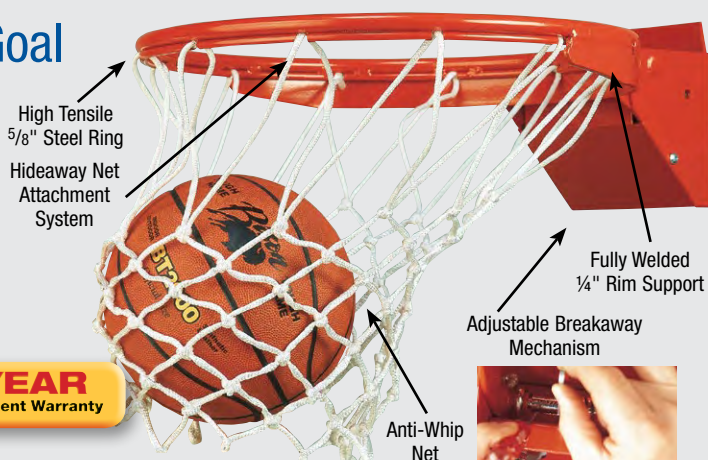

Meets **NCAA Rule** regarding rebound elasticity

AcuFlex™ Adjustable Tension Breakaway Mechanism

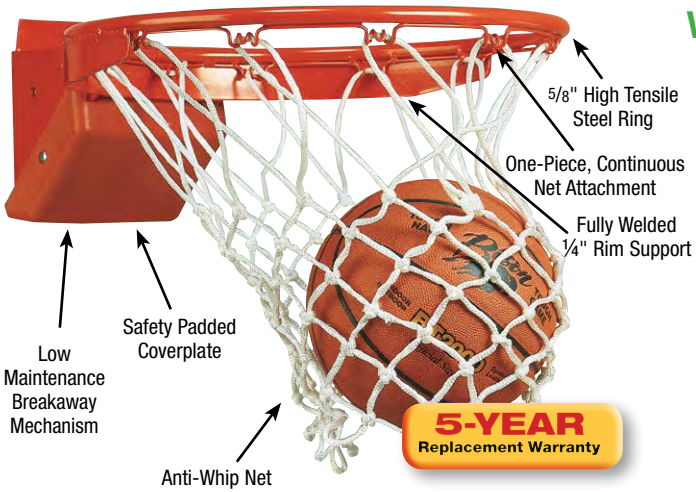

v BA35E Elite™ Breakaway

Compare our fully welded 1/4" rim support with the 3/16" partially welded supports of other manufacturers... High tensile strength 5/8" steel ring provides 50% greater bend resistance than normal rim material • One-piece continuous net attachment system reduces net attachment worries • Low maintenance breakaway mechanism is enclosed by Bison's exclusive safety padded coverplate • Convenient six-point lubrication system insures the smoothest possible action • Backplate fits all hole patterns on 42" and 48" rectangular and fan-shaped glass backboards • Meets National High School Federation and NCAA standards • Includes hardware and anti-whip net • **Five-year limited warranty.** Approx. shipping weight: 25# each; Sm. Pkg.

5-YEAR Replacement Warranty

Meets **NCAA Rule** regarding rebound elasticity

AcuFlex™ Adjustable Tension Breakaway Mechanism



v BA35 ProTech™ Breakaway

Bison's original breakaway goal is still the best value...Heat treated ball and socket, positive lock mechanism provides excellent rebound consistency over the life of the goal • ¼" rim support • Simple, maintenance-free design • Steel coverplate • Backplate fits all hole patterns on 42" and 48" rectangular and fan-shaped glass backboards • Continuous netlocks • Meets National High School Federation and NCAA standards • Includes mounting hardware and competition net • **Unconditional three-year replacement warranty.** Approx. shipping weight: 23# each; Sm. Pkg.



3-YEAR
Replacement Warranty

Meets **NCAA Rule**
regarding rebound
elasticity

v BA35S ProTech™ Breakaway for 42" Short Backboard

For 42" glass backboards only...Same features as BA35 above except rim mounting hole pattern is 5" x 4" only • Results in bottom of backplate being approximately 1" higher on backboard • **Unconditional three-year replacement warranty.** Approx. shipping weight: 22# each; Sm. Pkg.



Meets **NCAA Rule**
regarding rebound
elasticity

Unconditional
1-YEAR
Limited Warranty

v BA34 TruFlex™ Breakaway

Now Value Priced

Economical yet durable...Meets or exceeds NCAA and National High School Federation standards • Same breakaway mechanism as Bison's BA35 ProTech goal • Steel coverplate • Backplate mounting pattern fits 42" and 48" high glass backboards • One-year limited warranty. Approx. shipping weight: 23# each; Sm. Pkg.



Unconditional
1-YEAR
Limited Warranty

v BA32XL Hang Tough™ Breakaway

Our most affordable competition breakaway goal...Same heavy-duty construction as ProTech but with simplified breakaway mechanism that provides consistent and long life for programs at all levels • Meets National High School Federation standards • Includes competition net and mounting hardware. Approx. shipping weight: 22# each; Sm Pkg.

Ring Testing For NCAA Division I Men's Basketball

Beginning in 2004-05, All competitive rings shall be tested for rebound/elasticity once before the season and once before the postseason. This should be done with a non-mechanical, tamper-proof, computational testing device that determines the amount of energy absorption as a calibration. The rebound/elasticity of any basket ring support system shall be within a 35% to 50% energy absorption range of total impact energy and within a 5% differential between baskets on the same court.

All breakaway goals ever manufactured by Bison are capable of meeting the rebound elasticity requirements of this rule. For information on this requirement, request Bison's *Position Paper on NCAA Rules Regarding Rebound/Elasticity Testing of Competition Goals*. The actual testing device and complete instructions can be rented from Bison.

NOTICE: THIS RULE APPLIES ONLY TO MEN'S DIVISION I COMPETITION BASKETBALL COURTS.

BA51H Anti-Whip Net

Order BA51H-PK for a pink net.

Competition grade, affordable price...Heavy braided nylon to reduce net whip common with lighter weight nets • Bright white • Use for competition or as upgrade to normal residential or playground string nets. **Note: Pink nets for non-competition indoor use only.** Approx. shipping weight: 1#; Sm. Pkg.



BA51H

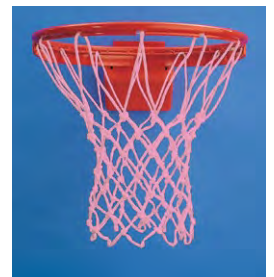

BA51H-PK

BA35ARC Replacement Hideaway Net Attachment Cables

Vinyl coated wire replacement cables to attach net to all Bison goals with tubular Hideaway Net Attachment System...Sold in pairs.

Approx. shipping weight: 1#/pair; Sm. Pkg.



Basketball Goals



BA32 Heavy-Duty Side Court and Recreational Flex Goal

An affordable flex goal that can take heavy use and abuse...Simple, low-maintenance design can be used indoors or outdoors • 5/8" steel rim with 3/16" x 1 1/2" support • 15° deflection, auto return • Universal backplate mounts to all standard boards • Durable powder coated finish • Not recommended for interscholastic high school or collegiate play • Continuous netlocks • Includes mounting hardware and nylon net • One-year limited warranty. Approx. shipping weight: 22# each; Sm. Pkg.



BA27A Front Mount Super Goal

Excellent upgrade from standard front mount goals at a lower cost than double rim or breakaway goals...Full 5/8" computer designed reinforcing bar gives "super support" when a player suspends from the goal • Additional 5/8" brace strengthens the vulnerable joint between rim and backplate • Continuous netlocks • 1/4" thick universal backplate • Packaged two goals per carton • Includes mounting hardware and nylon net • Two-year limited warranty. Approx. shipping weight: 17# each; Sm. Pkg.

BA27 (not shown) Standard Front Mount Competition Goal

Standard 5/8" steel rim...3/16" thick universal backplate for mounting to virtually all boards • 1/2" reinforcing bar, computer engineered for maximum support • Continuous netlocks • High-penetration continuous welded joints • Durable powder coated finish • Packaged two goals per carton • Includes mounting hardware and nylon net • One-year limited warranty. Approx. shipping weight: 13# each; Sm. Pkg.

Rear mount goals are recommended for replacement only. Rear mount goals are not compatible with any Bison pole systems.

BA32RXT FlexCourt™ Rear Mount Flex Goal

Rear mount backboard protection with same proven mechanism as Bison's popular BA32 flex goal...Fits all brands of rear mount steel backboards • Fully enclosed mechanism • Continuous netlocks • High tensile strength 5/8" rim • Includes mounting hardware and nylon net • One-year limited warranty. Approx. shipping weight: 20# each; Sm. Pkg.



BA21A Rear Mount Super Goal

Stronger than other manufacturers' standard rear mount goals...1/4" continuous welded support ring for over half of the rim circumference • Continuous netlocks • Heavy-duty 3/16" thick universal backplate mounts to all rear mount boards • Additional bracing at the backplate joint gives greater strength when player suspends from goal • Durable, baked powder coated finish • Packaged two goals per carton • Includes mounting hardware and nylon net • Two-year limited warranty. Approx. shipping weight: 20# each; Sm. Pkg.



BA21 (not shown) Standard Rear Mount Competition Goal

Replace bent and broken goals on any brand of rear mount backboard... Heavy-duty 3/16" welded backplate assembly • 3/16" support ring for over 1/2 of the rim circumference • Continuous netlocks • Universal backplate • Durable, baked powder coated finish • Packaged two goals per carton • Includes mounting hardware and nylon net • One-year limited warranty. Approx. shipping weight: 20# each; Sm. Pkg.

Training Aids



TR22 Three Point Shooter
Installs without tools on any goal...

Reduces shooting target from normal ring's 18" diameter to 16" • This 20% reduction in area will train the shooter to hit a smaller target • Normal goal looks like a great big bucket during games • A must for developing players to dramatically increase their shooting percentage • Fits residential goals, too • One-year limited warranty. Approx. shipping weight: 4#; Sm. Pkg.



TR23 10 1/2" Rebound Ring
Develops rebound skills by insuring the ball will not drop during rebound practice...Durable solid steel construction • Orange finish • Mounts easily on most standard 5/8" x 18" goals • One-year limited warranty. Approx. shipping weight: 3#; Sm. Pkg.

Removable Goals



TR75 Removable Goal Package
Excellent option to add shooting stations to areas

where a permanent goal would interfere with other activities...Official size goal slides easily into mounting track for quick on and off • Bracket can be mounted directly to wall or any flat surface • **Not suitable for slam dunk action** • Select wall mounting anchors (not included) based on wall construction • One-year limited warranty. Approx. shipping weight: 12#; Sm. Pkg.

TR74 Removable Goal Bracket

Includes wall bracket only... Same bracket as TR75 at right • Use with BA26 goal only • **Not suitable for slam dunk action** • Customer provides wall mount anchors • One-year limited warranty. Approx. shipping weight: 2#; Sm. Pkg.

TR76 Double Height Removable Goal Bracket

Allows 12" goal height adjustment... Wall bracket only • Mount goal higher for upper grades and lower for younger kids • Use with BA26 goal only • **Not suitable for slam dunk action** • Customer provides wall mount anchors • One-year limited warranty. Approx. shipping weight: 4#; Sm. Pkg.



BA26 Economy Goal
Our most affordable goal... Affordable, yet features official size and powder coated finish • Multiple hole pattern fits many common, low cost backboards • Complete with nylon net and hardware • Use with TR74 and TR76 • Note: Will not fit 5" x 5" and 5" x 4 1/2" mounting patterns • 90-day limited warranty. Approx. shipping weight: 11# each; Sm. Pkg.



TR70RP Rim Removal Pole and Bushing
Remove the rim from TR75, TR76, TR95 or TR96 without leaving the ground...Just screw pole into threaded bushing in rim and lift for safe and easy rim removal to avoid unwanted use, vandalism or theft • For use by adults only. Approx. shipping weight: 5#; Sm. Pkg.



Easy-Up™ Youth Mini Goals

Over 40,000 Easy-Up™ Mini Goals are in service in youth camps, YMCAs, YWCAs, elementary schools, church recreation centers, basketball camps and city recreation facilities.

For over 25 years, Easy-Up has put the rim within reach and helped to teach aspiring young basketball players proper shooting techniques... Equipment with official 10' goal height can be converted in less than five minutes with no use of tools • Only Easy-Up will fit on any style of single-ring goal, breakaway or non-breakaway, regardless of manufacturer, age or condition • An Easy-Up goal lowers rim and moves rim 24" closer to free throw line • The full size rim allows play with either full sized or reduced size balls depending upon player age • Standing as low as 2' above the floor, one person can easily attach the tubular frame to a 10' goal with a unique cam operated lever • Total system weight is less than 40# • 48" x 32" backboard is molded of high impact ABS plastic • Ships completely assembled • Not suitable for dunking or hanging from goal • One-year limited warranty on structure and goal, **lifetime limited warranty on backboard.**

v **TR86 6-in-1 Adjustable Easy-Up™**

Age appropriate goal height for kids of all ages now available in single adjustable unit...This one model can be set at 6½', 7', 7½', 8', 8½' or 9' goal height for kids as young as four years old • Two minute height adjustment without tools. Approx. shipping weight: 45#; Sm. Pkg.

Now with **SIX HEIGHT SETTINGS**

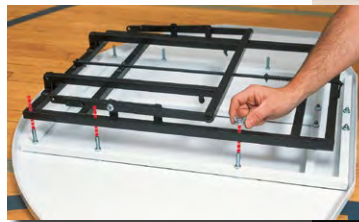

6-in-1 Adjustment is Quick and Easy



TR86 6-in-1 Adjustable 6½' to 9' Goal for Any Age



Less Than 40# Lifting Weight



For Transport or Storage
Folds with three thumb screws to 48" x 32" x 7" and has built-in carrying handle.



7½' Goal Height for Ages 3-5



8' Goal Height for Ages 5-7



8½' Goal Height for Ages 8-10

WARNING!
Easy-Up Youth Mini Goals are not for residential or outdoor institutional use. Adult installation is required. Use in supervised play only. **ABSOLUTELY NO HANGING OR DUNKING.**





Heavy-Duty Ball Carts **These May Be the Last Ball Carts You'll Ever Buy**

Possibly the last ball cart you'll ever need to buy... Designed and tested to support up to 250#, these carts might last forever • Constructed of welded 1" square heavy wall tubing with 3/4" steel chrome plated, horizontal ball supports • Choose from standard or lockable model with ball capacities to match your program's needs • Carts are available in five popular colors and can be customized with optional ABC92 lettering • Fits men's or women's basketballs • Floor-friendly casters • Some assembly required • **Five-year limited warranty.**



BA185-SC with Optional ABC92 Lettering

BA125-RY with Optional ABC92 Lettering



BA165-SV with Optional ABC92 Lettering



Lockable Ball Carts Locking End
Carts now have capacity for 16 or 24 balls... Lock to protect your basketball investment • Customer provides padlock • 23" width for easy storage • Six color options • Lettering can be applied on one end (two lines) • **Five-year limited warranty.**

BA165 Ball Cart

16 ball capacity. Approx. shipping weight: 80#; Sm. Pkg.

BA245 Ball Cart

24 ball capacity. Approx. shipping weight: 100#; Sm. Pkg.

Ball Carts

Choose a cart for 12 or 18 balls... Choice of six colors • Lettering can be applied on both ends • The best ball carts you'll ever own • **Five-year limited warranty.**

BA125 Ball Cart

Holds 12 balls. Approx. shipping weight: 40#; Sm. Pkg.

BA185 Ball Cart

Holds 18 balls. Approx. shipping weight: 50#; Sm. Pkg.



BA175

BA175 25 Ball Security Locker

Secure your investment in inflatables... Sturdy blue powder coated wire and tubular locker • Hinged, lockable top (lock not included) • Overall dimensions 24" (w) x 36" (l) x 35" (h) • Easy to roll with convenient handle and heavy-duty swivel casters • Holds approximately 25 to 30 basketballs, volleyballs, soccer or miscellaneous game balls and equipment • **One-year limited warranty.**

Approx. shipping weight: 50#; Sm. Pkg. Ships Oversize

Standard Ball Carts

Economical and convenient ball storage and transport carts... These sturdy carts have chrome plated tubing framework • Extra wide casters add stability and allow easy turning • Choose from 12 or 16 ball capacity • Some assembly required.



BA150

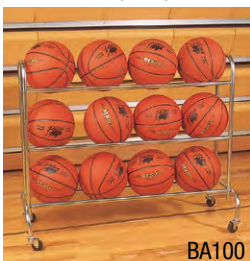

BA100

BA100 Standard 12 Ball Cart

Approx. shipping weight: 13#; Sm. Pkg.

BA150 Standard 16 Ball Cart

Approx. shipping weight: 15#; Sm. Pkg.

ABC92 Custom Lettering

Custom lettering for your school name or nickname... End panels on select Bison ball carts can be customized with up to 10 letters per side or line • See page 102 for vinyl lettering color options • Choose one of the four lettering styles shown below (A, B, C or D) • Customer applies lettering at assembly • Includes same lettering for both ends of cart on BA125 and BA185 or two lines of lettering on BA165 and BA245 • Inquire about logo printing options.

ABC92 Letter Styles



Color Selection for BA125, BA165, BA185 and BA245 Ball Carts



Wall Mounted Basketball Scoreboards

Choose from two popular sizes...100% solid state electronics • Scoreboard package includes a tabletop 110-volt control console and 200' of control cable
 • Sturdy aluminum extrusion framework • Built-in sponsor or team logo space • Black background finish • 12" red clock digits and 12" yellow score digits
 • 9" green period digit and bonus possessions • 99:59 clock has 1/10 second countdown under 1:00 and an internal horn • 120 VAC, 1 amp, 60 Hz. power requirement • Unlimited options for full-color graphics for a school or sponsor display • Always consult Bison Construction Specialist to assure proper ordering
 • One hour of services by Bison Art Department are provided free of charge • Five-year limited warranty.



SC2000



SC1000



SC500 Slimline Possession Arrow
Space saving thin design...Leaves more room for score-keeper duties • Bright red illuminated electronic arrows
 • 120 volt, 6" power cord 6" (h) x 20" (w) x 2" (d) enclosure
 • One-year limited warranty. Approx. shipping weight: 5#; Sm. Pkg.



Remote Operation



Back Panel Operation



SC2000 Basketball Scoreboard

Overall dimensions: 156" (l) x 60" (h) x 6" (d)...Includes a 48" (W) x 60" (h) sponsor or team logo panel. Approx. shipping weight: 515#; Truck

SC1000 Basketball Scoreboard

Overall dimensions: 144" (l) x 35" (h) x 6" (d)...Includes a 36" (w) x 35" (h) sponsor or team logo panel. Approx. shipping weight: 351#; Truck

SC20WR Wireless Remote Scoreboard Control System

(not shown)
Make installation easier...Optional remote control console and receiver replace tabletop control console and control cable on SC1000 and SC2000 • Five-year limited warranty. Approx. shipping weight: 2#; Sm. Pkg.



Shot Clocks

These 120V shot clocks have 12" high digits and are integrated with Bison SC2000 and SC1000 scoreboards...Overall cabinet size 24" (w) x 27" (h) • Order **SC450I** for shot clocks integrated with scoreboards
 • Order **SC450S** for standard stand alone shot clock system • Order **SC20ER** for an extra receiver • Contact a Bison Product Specialist for shot clock brackets and details • Sold in pairs. Approx. shipping weight: 40#/pair; Sm. Pkg.

Bison now offers popular LED Backboard Alert Systems that mount easily without hardware on all Bison and most other manufacturers' official size 42" x 72" or 48" x 72" glass backboards and is compatible with virtually all manufacturers' scoreboards. Consult a Bison Product Specialist before ordering.

See page 19 for complete details.



Maximize school, team or program spirit by including Bison Sports Pride™ equipment in your plans when you redecorate, renovate or build your facility. Bison's design team will work with you using your existing logos or artwork, work from your rough concept or show you a variety of awesome stock standard team logos.

Choose from a wide variety of Bison sport and event related equipment, all designed taking advantage of our full color printing resulting in color photo quality images.



Design



Print



Laminate



Graphic Wall Padding



Covered Benches



Scoring Tables



Team Chairs



Lettering and Logos



Windscreens and Banners



Padding Wraps

Sport Pride™ Illuminated Scoring Tables

Let the light shine through with Bison Sport Pride Illuminated

Scoring Tables... Tables have profile identical to Bison's full color graphic and lettered scoring table models so tables can be configured in any length and in any combination of styles to meet your facility's needs and budget • Support legs and 16" deep table top fold for easy transport and storage on built-in, non-marking casters • Front graphics are printed on a durable, translucent substrate and protected by unbreakable clear polycarbonate for a lifetime of sharp, bright images • Price includes free artwork design by Bison art department using virtually any photo quality image, logo artwork or lettering • Choose 8' or 4' table length • Can be used either on the floor with chairs or mounted on a customer fabricated platform a few rows up in most bleachers

- Ends are fully padded and can be lettered with school name • Top edge has matching safety padding • Each 8' table includes a FREE possession arrow and a 120 volt power strip with surge protector • See Convertible drawing on page 28 for profile information
- Requires 20 amp, 120 volt service
- Illumination is provided by three fluorescent lamps (included) • Due to their custom design, scoring tables and wall padding are not returnable • Five-year limited warranty on tables except lamps.

Approx. shipping weight: 400#; Truck



ST85FI 8' Floor Table



FREE!
SC500 Possession Arrow
on 8' Scoring Table

Sport Pride Illuminated Scoring Tables

	ST45FI	ST85FI
Style	4' Convertible	8' Convertible
Approx. Graphic Size	31" x 48" (10 sq. ft.)	31" x 96" (20 sq. ft.)
Actual Overall Dimensions	34" (w) x 34" (h) x 54" (l)	34" (w) x 34" (h) x 102" (l)
Power Requirement	120 Volt AC, 20 AMP	120 Volt AC, 20 AMP
Table Depth and Height	16" (d) x 31" (h)	16" (d) x 31" (h)
Stored Dimensions	20" (w) x 34" (h) x 54" (l)	20" (w) x 34" (h) x 102" (l)
Shipping Weight (Truck)	250#	400#
Unit Weight	175#	300#
Optional Protective Cover	ST45FCV	ST85FCV
Possession Arrow Included	No	Yes

SPORT PRIDE™ FULL COLOR GRAPHIC SCORERS TABLES



ST85F 8' Convertible Table on Floor

FREE!
SC500 Possession Arrow
with 12' and 8' Sport Pride
Scoring Tables

**Now Value
Priced**

Sport Pride™ Full Color Graphic Scorers Tables

The perfect blend of safety, function and school pride...

- Realistic color graphics, same as found on our popular Sport Pride wall padding, cover the entire front and sides of these scorers tables • Available in 12', 8' or 4' models • Any number of 12', 8' and 4' tables can be placed side-by-side with graphics coordinated to create any length of continuous scorers table capacity • Tables fold easily for transport and storage • Choose from Convertible or Space Saver models • Includes full color printed graphics on front panel and mascot or school name on each side pad • Super narrow storage width • Full color printing process allows infinite color selection • One hour of FREE custom artwork by Bison art department (BNART) • Printed surfaces are clear laminated to protect graphics • Folding 16" deep table with drink holders • Padded front and sides have 14 oz. anti-mildew, UV protected and fire-retardant vinyl over 2" thick urethane foam • Steel and aluminum structure with powder coated and anodized finish • Built-in, floor-friendly transport casters • 110 volt receptacles for computer, shot clock, etc. • Optional protective cover available for 8' models • Due to their custom design, scoring tables and wall padding are not returnable • One-year limited warranty.





ST125F 12' Convertible Table in Bleachers (requires field constructed platform)



ST85B
8' Space Saver Table



Two ST85F 8' Convertible Tables, 16' Total Length



ST45F 4' Convertible Table on Floor



Compact for Easy Storage

Sport Pride™ Graphic, Lettered and Solid Color Scorers Tables					
	ST125F ST125FL ST125FS	V ST85F ST85FL ST85FS	V ST85B ST85BL ST85BS	ST45F ST45FL ST45FS	ST45B ST45BL ST45BS
Style (Seats)	12' Convertible (6)	8' Convertible (4)	8' Space Saver (4)	4' Convertible (2)	4' Space Saver (2)
Approx. Graphic Size	34" x 144" (36 sq. ft.)	34" x 96" (24 sq. ft.)	46" x 96" (32 sq. ft.)	34" x 48" (12 sq. ft.)	46" x 48" (16 sq. ft.)
Approx. Overall Dimensions	34" (w) x 34" (h) x 144" (l)	34" (w) x 34" (h) x 96" (l)	34" (w) x 46" (h) x 96" (l)	34" (w) x 34" (h) x 48" (l)	34" (w) x 46" (h) x 48" (l)
Graphics	Full Color Two-Color Lettering Solid Color	Full Color Two-Color Lettering Solid Color	Full Color Two-Color Lettering Solid Color	Full Color Two-Color Lettering Solid Color	Full Color Two-Color Lettering Solid Color
Table Depth and Height	16" (d) x 31" (h)	16" (d) x 31" (h)	16" (d) x 41" (h)	16" (d) x 31" (h)	16" (d) x 41" (h)
Stored Dimensions	20" (w) x 34" (h) x 144" (l)	20" (w) x 34" (h) x 96" (l)	20" (w) x 46" (h) x 96" (l)	20" (w) x 34" (h) x 48" (l)	20" (w) x 46" (h) x 48" (l)
Shipping Weight (Truck)	400#	350#	400#	225#	250#
Unit Weight	300#	250#	300#	150#	175#
Optional Protective Cover	ST125FCV	ST85FCV	ST85BCV	ST45FCV	ST45BCV
Possession Arrow Included	Yes	Yes	Yes	No	No

Scorers' Table Dimensions

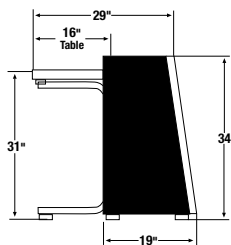

All Convertible Tables on Floor

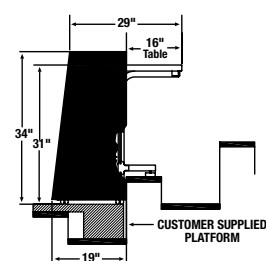

All Convertible Tables in Bleachers

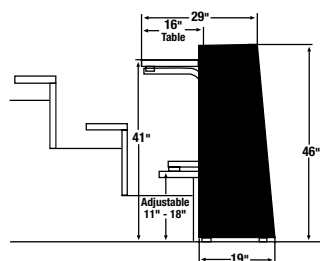

All Space Saver Tables



"Mt. Olive is a small school and it was nice to have someone pay attention to every detail to make our scorers table the very best. Our Sports Boosters donated the money to purchase a Bison Sport Pride scorers table and they wanted our table to mirror the Wildcat painting in our gym. The customer service I received was second to none and the artwork is amazing!"



Drew Logan,
High School Basketball Coach
Mt. Olive High School, Mt. Olive, IL



Sport Pride™ Lettered Scorers Tables

Same great Bison scorers tables previously available only with full colored printed graphics are now available with two-color front lettering and side lettering at a significant savings...Sport Pride lettered scorers tables are available in many vinyl background colors with multiple lettering color options so you won't have to sacrifice appearance to fit a great scorers table into your budget

- Choose from the lettering styles shown • See page 102 for padding and lettering color options • Bison graphics department will provide sample layouts for approval • Optional oversize two-color (ABC50) logos can be included in the design at an additional cost, call for details
- Some lettering size limitations apply • All lettering and logos are applied using specially formulated ink for maximum life • Tables can also be ordered in solid colors with no lettering • Due to their custom design, scoring tables and wall padding are not returnable • One-year limited warranty • More details on chart on page 28.



ST85FL 8' Convertible Lettered Table in Bleachers (requires field constructed platform) Shown with Optional SC500 Possession Arrow



ST85FS 8' Convertible Solid Color Table on Floor Shown with SC500 Optional Possession Arrow



Letter Styles

A **ABC** c *ABC* B **ABC** D **ABC**

"The Bison scorers table we purchased was more than we bargained for! The graphics were outstanding, the quality was excellent and the price was reasonable. I was impressed with the turnaround time and how well it was constructed. It has had a positive impact on our school spirit. Anyone who walks into the gym notices the table right away. When people ask who we got it from, I direct them to Bison with positive recommendations."

Rob Murphy
St. Ignatius
High School
Thunder Bay, Ontario



Scorers Table Protective Covers

Lightweight but durable black nylon...Protective covers are custom fit to reduce dust and damage during transport and storage of your Bison Sport Pride scorers tables • See chart on page 28 to select cover to fit the table ordered. Approx. shipping weight: 5#; Sm. Pkg.



ST870 7½' Outdoor Sports Scoring Table



Scoring tables are not only for indoor sports

any longer...Use for soccer, softball, baseball or any outdoor team sports • 7½' table seats up to 4 persons and provides a convenient 20" deep table top for scorebooks, computers or microphones

- Constructed of 2" square powder coated steel tubing and 2" x 10" anodized aluminum planks • Sits on molded rubber foot pads to protect powder coating, add stability and reduce potential for rust from wet turf • Optional powder coated aluminum planks and available in six colors (see page 79) • Two year limited warranty. Approx. shipping weight: 140#; Truck





ST84F and ST83F 8' School Spirit™ Activity Tables

Step up to the big leagues... But at a little league price • Great for use as a basketball or volleyball scorers table but equally at home at speech and debate, wrestling matches, bake sales or anywhere school spirit is alive and well • Front and side panels are fully padded for player protection • Printing of full color graphics on the front panel and mascot or school name on side panels is included in price of ST84F • Easy to store, all panels attach with Velcro • Padded front panel is approximately 30" x 96" • 2" thick front and 1" thick side padding • Seats four comfortably • Full color graphics with clear laminate protective coat (ST84F) or choose from 16 padding colors shown on page 102 with no graphics (ST83F) • 5 minute set up and tear down • Stores in area 8' x 3' x 1' • Full 30" x 96" table top • One-year limited warranty.

ST84F
Shown with Optional
SC500 Possession Arrow



ST83F Shown with
Optional SC500 Possession Arrow

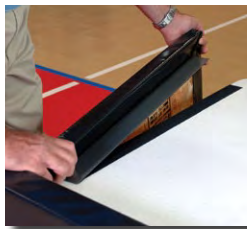

Velcro Front and Side
Panel Attachment



Easy Transport
and Storage

School Spirit™ Activity Tables

	ST84F	ST83F
Style	8' Floor	8' Floor
Approx. Graphic Size	30" x 100"	N/A
Approx. Overall Dimensions	32" (w) x 30" (h) x 100" (l)	32" (w) x 30" (h) x 100" (l)
Table Depth and Height	30" (d) x 29" (h)	30" (d) x 29" (h)
Stored Dimensions	12" (w) x 36" (h) x 96" (l)	12" (w) x 36" (h) x 96" (l)
Shipping Weight (Truck)	130#	130#
Unit Weight	90#	90#
Possession Arrow Included	No	No



ST54F

ST54F 5' School Spirit™ Compact Activity Table

Great graphics, easy to transport... Budget priced 60" table seats two comfortably for sports events, ticket sales or event check-in • Displays your school mascot proudly just like more expensive graphic tables but at a fraction of the cost • Vinyl skirt is permanently printed and laminated using a full color graphic process and attaches to foldable table with super-duty Velcro fastening tape • There is no additional artwork charge if ordered using Bison's QwikPrint graphics • Table height 29", table depth 27" • Stored size 4" (w) x 27" (h) x 30" (l) • Graphic skirt is rolled and stored in zippered storage bag for safekeeping • Chairs not included • One-year limited warranty.

Approx. shipping weight: 35#; Sm. Pkg.

School Spirit™ Compact Activity Table

	ST54F
Style	5' Floor
Approx. Graphic Size	29" x 60"
Approx. Overall Dimensions	27" (w) x 29" (h) x 60" (l)
Table Depth and Height	27" (d) x 29" (h)
Stored Dimensions	4" (w) x 27" (h) x 30" (l)
Shipping Weight (Truck)	35#
Unit Weight	30#
Possession Arrow Included	No



ST89F

ST89F 8' School Spirit™ Activity Table Skirt

You provide the table, we'll provide the skirt... Provides top quality graphics for any 8' long, 29" high and 30" deep folding table • Skirt is printed on heavy-duty vinyl using our full color graphic process then laminated for superior durability • Attaches to customer supplied table using super-duty Velcro • Chairs not included • Includes cover and zippered storage bag • No additional artwork charges apply if Bison QwikPrint graphics are used • One-year limited warranty. Approx. shipping weight: 10#; Sm. Pkg.

Sample Mascot Images Available at
www.bisoninc.com/sportpride





Team Chairs Upgraded for Superior Comfort and Durability



STC500S Sport Pride™ Team Chairs

Upgraded for superior durability... Now with .75" x 1.63" rectangular legs and support structures but with the same comfortable 2½" thick padded, 18" wide seat • Compare with other manufacturer's seats with lighter weight steel legs, thinner padding or inferior construction • Available in a wide variety of frame and vinyl cover colors and a nearly infinite array of 1 or 2-color silk screened logo and lettering options • Minimum order 4 chairs • Work with Bison custom art specialist to select frame and vinyl color and to design great custom lettering and logo designs • Each order must include STCART setup and artwork charges • Choose from Black, Maroon, Scarlet, Orange, Kelly, Forest, Royal, Navy, Purple and White frames • Choose from Black, White, Scarlet, Maroon, Orange, Purple, Royal, Navy or Forest vinyl seat covers • See STC036 below for transport cart • Now with three-year limited warranty. Approx. shipping weight: 20#/per chair.



STC300S Sport Pride™ Team Stools

Instant seating wherever you want it... Locker rooms, game timeouts or any time • Full color, custom printed padded seat • Tubular steel frame • 20" comfortable seat height • Must be ordered in multiples of five • Each order that includes printing must include STCART set up and artwork charge • Bison's Art Department will assist in design • Contact a Bison Graphics Specialist for frame and seat color options • One-year limited warranty. Approx. shipping weight: 8#/per stool; Sm. Pkg.



STC036 Sport Pride™ Chair Transport Cart

Stores up to 36 Team Chairs or up to 60 Event Chairs...

Transports, too • Floor friendly casters • Solid steel frame

- Loaded dimensions 31" (w) x 60" (l) x 75" (h)
- One-year limited warranty.

Approx. shipping weight: 120#/ Truck



STC100 Sport Pride™ Chair Back Covers

Customize standard folding chairs...Show your program's spirit

- Full color graphic printing for logos and lettering • Durable sewn vinyl construction • Fits Bison Team and Event chairs and most standard folding chairs • Bison's Art Department will assist in design • Minimum order of four chair covers • Each order must include one STCART set up and artwork charge. Approx. shipping weight: 1#/each; Sm. Pkg.



INDOOR AND OUTDOOR PADDING SYSTEMS

If you need safety padding...we've got you covered. Bison has the perfect team to design and construct padding to protect players from virtually any surface from simple flat walls to columns, doorways, fences and overhead obstructions. With a wide variety of foams, fabrics, backing substrates and mounting methods, we will help you provide the padding system that best satisfies your program's needs. Let our graphic design staff work with you to make your padding system not only offer superior safety but also exhibit your program pride with full color, durable graphic designs.



Full Color Graphic Wall Pads



1 or 2 Color Lettered Wall Pads



Solid Color Wall Pads



Entry Padding



Round or Square Column Padding



Stage or Corner Padding



Custom Factory Cutouts (WP25)



Molded Outlet Openings (WP20F)



Chain Link Railing Wraps (WPRAIL)



Custom Outdoor Padding Systems

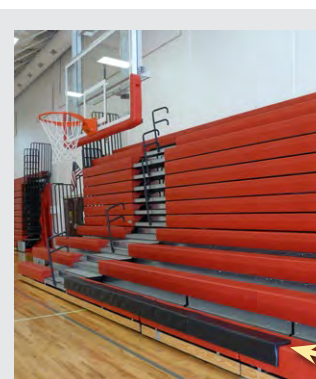

Removable Bleacher Padding



Standard Flange Mounting



Hidden Z Track Mounting



Chain Link Mounting (WPC)

WP466 Economy Bleacher and Stage Padding

Protect your players from contact injuries...at an economy price • Each pad is 4' long, 1" thick and forms a 6" x 6" 90° angle • Black sewn 14 oz. vinyl covering • Velcro attachment system included • Set of 4 covers a total of 16' • Perfect for gyms with permanent bleachers that are too close to basketball end lines during side court use • One-year warranty. Approx. shipping weight 25# set of 4, Sm. Pkg.





Sport Pride™ Graphic Wall Padding

Add the **WOW!** factor to your indoor or outdoor athletic facility with Sport Pride™ full color graphic wall padding...The options are limited only by your imagination • Our creative art department offers exciting photo or logo reproduction and an infinite range of colors that make simple, one color padding seem, well, boring • Digitally printed graphics are far superior to silk screened or vinyl stick-ons in both image quality and durability • Protect your graphic padding investment with Protective Curtains (see page 34) • Bison Sport Pride graphic wall padding is an excellent project for booster club fundraisers to celebrate state championships or as a component of a gym renovation.

All Sport Pride™ graphic wall padding includes Hidden "Z" Track Mounting system • See page 35 for size and style ordering chart • All printed graphic wall padding is protected with a Duralam™ clear coating • Optional protective covers are available for 6', 7' and 8' padding heights • Consult a Bison Product Specialist to assure proper ordering.

16' Below Backboard Padding Systems

**SAVE \$\$\$
WITH 16'
PACKAGES**

Save money by selecting Below Backboard Wall Padding Systems...One-easy-to-order model number provides player protection a full 5' on either side of the 6' wide backboard • 16' is the commonly recommended width and is especially important if the wall is less than 10' from the end line of the basketball court • Below Backboard Systems are available in your choice of 6', 7' or 8' heights • Electrical outlets or other wall protrusions can be accommodated by adding optional cutouts for an additional cost • All Sport Pride graphic 16' systems are provided with Hidden "Z" Track Mounting Systems • Typical 16' installations consist of four, 4' wide panels but occasionally wall configurations dictate different width panels • A 16' system may be combined with additional individual panels • Consult a Bison Product Specialist for details regarding color options, cutouts, graphic layout and special padding configurations at time of initial order.



Hidden "Z" Track Mounting System (WPZ) is standard with all Sport Pride™ Graphic and Lettered Wall Padding unless otherwise specified.

Mixing Graphic with Unprinted Wall Padding

Since all Sport Pride graphic wall padding is printed on a white-based vinyl material, the colors, including the background color are digitally determined. While it is possible to approximate the color of existing precolored vinyl used on unprinted Bison Protector™ wall padding, it is impossible to accomplish an exact match.



If your project calls for a significant number of panels with no graphics, and you want to take advantage of the lower cost of unprinted padding for those panels, care should be taken in the graphic design to minimize the effect of the color difference. To have an exact match requires "graphic free" panels to be ordered as Sport Pride graphic padding. Call Bison for details.



Protector™ Lettered Wall Padding

Show your home team pride...Make a statement on solid colored wall padding with custom one- or two-colored lettering • Choose lettering style from the options below • Selection of 4' wide instead of 2' wide panels enhances the ability to lay out your custom padding with smaller or more letters • Bison art department will provide free assistance and sample layouts.

Letter Styles

A ABC *e ABC*
B ABC **D ABC**



Lettered wall padding includes Hidden "Z" Track Mounting system • See below for typical indoor padding specifications • See page 35 for size and style ordering chart • See page 102 for vinyl color options and available lettering color options • Individual letters must fit on a single 2' wide or 4' wide panel • Consult a Bison Product Specialist to assure proper ordering.

SAVE \$\$\$
 WITH 16'
 PACKAGES



16' Lettered Below Backboard Padding Systems

Order typical 16' wide padding system with a single model number and save money • Available in 6', 7' or 8' high sizes • See page 35 or consult a Bison Product Specialist for ordering details.



Wall Padding Protective Curtains

Maintain the impact of your Sport Pride or Protector wall padding... Reduce the temptation for vandalism and prevent unnecessary scuffing while still maintaining all

your wall padding's safety features • These lightweight black nylon curtains have fully hemmed edges and a full length Velcro top attachment strip that is designed to attach to Bison wall padding • Includes appropriate length of 3/4" wide adhesive backed Velcro strip to attach to top of padding • Consult a Bison Product Specialist for ordering information. Approx. shipping weight: 2#; Sm. Pkg.

Standard Indoor Wall Padding Specifications

Unless otherwise indicated, all indoor Full-Color Graphic, Two-Color Lettered, and Solid Color vinyl indoor wall padding is constructed of 7/16" OSB composite board backing with adhesive applied 2" fire retardant Reflex Plus urethane foam. Leather grain (Two-Color Lettered and Solid Color styles) flame-, mildew-, and UV-resistant 14 oz. vinyl is tightly stretched around foam and secured to OSB backing by means of staples no less than 2" apart. Full-Color Graphic padding is protected with DuraLam™ liquid laminate. Full color graphic and lettered vinyl padding come standard with hidden "Z" channel mounting. Solid color vinyl padding can be ordered with standard flange or optional hidden mount style. Specifications may vary on custom sizes, shapes, and configurations to meet site-specific requirements.

Contact a Bison Customer Service Specialist for details regarding other foam density, foam thickness and fire retardant specification options.



Protector™ Solid Color Padding

Protect your players and add color to your gym at the same time...

This padding that has all the safety, durability and quality of our graphic and lettered padding but is priced to allow more square feet of padding for your dollar • Choose from any of our standard vinyl colors shown on page 102 • Choose a single color for your entire wall or alternate compatible school colors at no extra cost to maximize the aesthetic appeal • Actual vinyl color samples are available free of charge on request • If choosing two colors, it is best to have an odd number of panels to allow the end panels to be the same color.

Solid color padding can be ordered with either Standard Flange Style or Hidden "Z" Track Mounting Systems • See page 102 for vinyl color options • Consult a Bison Product Specialist to assure proper ordering.



16' Solid Color Below Backboard Padding Systems

You'll save money and make ordering easy with this all-in-one system • Can be ordered with either Standard Flange Style or Hidden "Z" Track Mounting systems • If you want to alternate two solid colors, you will want to select 2' wide panels and add an additional 2' wide panel to have the same color on both ends of an 18' padded wall.

Protector™ Solid Color Padding is available in either Standard Flange Mount or Hidden "Z" Track design.

Standard Size Indoor Wall Padding Style and Size Chart

Panel Size (Contact Bison for custom sizes and configurations)	 COLUMBUS BEARS Full Color Graphic	 MARSHALL EAGLES Lettered	 Solid Color	
	Hidden "Z" Track Mounting	Hidden "Z" Track Mounting	Hidden "Z"	Standard Flange
2' x 5'	WP52G	WP52L	WP52	WP52F
2' x 6'	WP62G	WP62L	WP62	WP62F
2' x 7'	WP72G	WP72L	WP72	WP72F
2' x 8'	WP82G	WP82L	WP82	WP82F
4' x 5'	WP54G	WP54L	WP54	WP54F
4' x 6'	WP64G	WP64L	WP64	WP64F
4' x 7'	WP74G	WP74L	WP74	WP74F
4' x 8'	WP84G	WP84L	WP84	WP84F
16' x 6' Wall (2' Wide Panels)	WP6216G	WP6216L	WP6216	WP6216F
16' x 6' Wall (4' Wide Panels)	WP6416G	WP6416L	WP6416	WP6416F
16' x 7' Wall (2' Wide Panels)	WP7216G	WP7216L	WP7216	WP7216F
16' x 7' Wall (4' Wide Panels)	WP7416G	WP7416L	WP7416	WP7416F
16' x 8' Wall (2' Wide Panels)	WP8216G	WP8216L	WP8216	WP8216F
16' x 8' Wall (4' Wide Panels)	WP8416G	WP8416L	WP8416	WP8416F



Baseball stadiums, football fields, soccer complexes...it doesn't matter the sport or the type of field, Bison can design customized solid color or full color printed graphic protective systems to help avoid contact injury. Walls, fences, poles, utility boxes, railings, dugouts, scoreboards and bleachers all create risks that can be avoided or reduced with careful consideration. Due to the custom nature of most outdoor padding needs, most projects are based on specific designs developed with our staff.



All Weather™ Outdoor Padding

Neither snow nor rain nor dark of night...Oh wait, that's the US Postal Service motto, but it also applies to our All Weather Outdoor Padding and you can add heat, humidity, hail, sleet, wind, sunlight, frost and virtually any other common weather term to describe our padding's durability • All Weather Padding features ¾" BC SYP exterior grade plywood, 100% rust-proof stainless steel, brass or aluminum hardware and fittings, 3" thick mildew-resistant polyurethane foam and heavy outdoor durable vinyl coverings • 17 sunfast solid color options, full color graphic or lettered options • Each assembled panel, regardless of size, is vented at the bottom to allow moisture to escape, increasing both functional and aesthetic longevity • Outdoor padding cost is computed by the square foot • Outdoor padding is available in all sizes, styles, custom configuration and colors of our indoor padding.

All Weather padding comes standard with flange style mounting but consult our Bison Padding Specialists to determine if optional **WPZ** "Z" Track Mounting, **WPC** Chain Link (included) or **WPV** Velcro Mounting better fits your specific needs for part or all of your installation.



Outdoor Padding Specifications

Unless otherwise indicated, all outdoor Full-Color Graphic, Two-Color Lettered, and Solid Color vinyl outdoor padding is constructed of ¾" FDN CCA treated southern yellow pine plywood with adhesive applied 3" anti-microbial urethane foam. Two-color Lettered and Solid-Color styles are covered with fabric-backed flame retardant and mildew- and UV-resistant 30 oz. vinyl with leather grain texture. Full-Color Graphic styles are covered with 14 oz. flame-, mildew-, and UV-resistant vinyl with DuraLam™ protective coating applied over the graphics. All vinyl is tightly stretched around the foam and stapled to the plywood with rust-proof stainless steel staples no less than 2" apart. Mounting styles will vary depending upon specific requirements. Specifications may vary on custom sizes, shapes, and configurations to meet site-specific requirements.



WPC Chain Link Padding Mounts

Mount outdoor padding securely to chain link fences... priced by the padding square foot. Sm. Pkg.



WPRAIL Fence Rail and Dugout **Padding**

Easy to order, easy to install...8" wide x 11" thick polyurethane foam is covered in 14 oz. vinyl in your choice of 16 popular colors • Standard length is 6' but can be made in shorter lengths as desired • Designed to wrap around typical chain link style fence with top rail up to 2½" diameter and attached with **WPRAILCT** cable ties (order separately)

- Will flex around corners if needed • Brass attachment grommets are spaced 6" apart for secure attachment • Padding is 100% sewn construction with high tensile outdoor thread
- Priced by the lineal foot. Approx. shipping weight: .5#/ft length; Sm. Pkg.



Football Goalpost Padding

See page 74 for details.

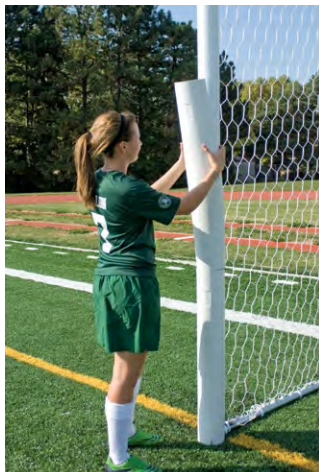

DuraSkin® Soccer Upright Padding

See page 72 for details.



Outdoor Basketball Post Padding

See page 91 for multiple options.



Outdoor Volleyball Safety Padding

See page 58 for details.

WS144G Sport Pride® Graphic Windscreens



Enhance your sports fields appearance...while you cut down annoying wind and provide a level of privacy • Full color graphic designs are unlimited • Let our graphic design team work with you to develop the perfect option for your fields • Printing is done on durable white 8 oz. mesh allowing wind to pass through the fabric extending life when compared to solid banners • Order two windscreens to provide printed images on both sides of fence • All wind screens are double stitch hemmed around the perimeter with grommets every 12" to provide secure attachment using **WPRAILCT** cable ties ordered separately (or provide your own) • Maximum screen size is 5' high x 100' long • Screens are priced by the square foot. Approx. Shipping Weight: 6#/100 Sq. Ft.; Sm. Pkg.



BN144 Sport Pride® Vinyl Banners

Show your school spirit indoors or outdoors...with these easy to order banners • Provide us complete artwork or work with our design staff to develop artwork from your conceptual ideas • Banners are common ways to memorialize state championships or other school accomplishments, recognize program donors, honor team participation, capture school records or just to enhance your facility with team logos and slogans • All banners have double stitched, hemmed edges and can be grommeted or provided with top and bottom rod pockets (rods supplied by customer) • Heavy 13 oz. outdoor durable banner fabric printed with outdoor durable inks • Maximum size is 5' x 50' • All banners are priced by the square foot (minimum charge per banner is 15 square foot regardless of actual size). Approx. Shipping Weight: 1#/10 sq. ft.; Sm. Pkg.



BN144R1 Sport Pride® Rigid Banners

Avoid wrinkles and premature wind damage...with high resolution, full color printed banners permanently mounted on Aluminum Composite Material (ACM) rigid, weatherproof mounting substrate • Order **BN144R1** for single sided graphics and **BN144R2** for double sided graphics • Rigid banners allow graphics printed on one or two sides for maximum viewing, an option not available on vinyl banner systems • Rigid banners are great for hanging from gym ceilings, attaching to walls or fences or virtually anywhere that a high quality image or message is desired • Maximum size is 48" x 96" • All rigid banners are priced by the square foot with a minimum charge of 15 square feet regardless of actual size • Rigid banners typically are supplied with no mounting or hanging holes but can be included at no charge if requested. Approx. Shipping Weight: 2#/sq. ft. Truck shipment if over 20 sq. ft., otherwise Sm. Pkg.



BN144R2 Sport Pride® Dual Image Rigid Banners

Some applications are just right for dual image rigid banners...suspend from gym rafters allowing viewing by fans on both sides of gym • Rigid banners don't wrinkle and are less prone to movement when doors open or HVAC systems come on • Same rigid substrate as BN144R1 above but with images on both sides • Images can be the same or different. Approx. shipping weight 2#/sq. ft. per 10 sq. ft. Truck shipment if over 20 sq. ft., otherwise Sm. Pkg.



Reverse side can be printed with the same (as shown) or a different message.



All facilities and programs are not created equal so it's not surprising that the selection of volleyball systems is not a one-style-fits-all proposition. Bison offers the widest range of designs available in the industry, one with features that will be the perfect fit for your program.



Carbon Fiber

VB7222 CarbonLite® Composite

The lightest weight competition volleyball system in the industry making it perfect for facilities where set up and tear down is frequent. The 3" outer post and telescoping inner pole are computer wound for maximum net tensioning despite the low weight to pole rigidity ratio.



Carbon Fiber/Aluminum

VB7000 CarbonMax®

Elite programs that want a super lightweight, easy to set up system with easy internal winder net height adjustment but are not willing to sacrifice rigidity and superior net tensioning will discover this is the best system on the market today. Carbon fiber is an investment in the latest volleyball technology.



Aluminum

VB1000 Centerline® Elite Aluminum

Division I and premier high school programs that desire the advantages of lightweight aluminum but are concerned about excessive deflection and net tensioning problems common with other aluminum systems are the most common buyers of this system.



Aluminum

VB6000 Match Point™ Aluminum

Designed for high schools on a budget, recreation centers and any facility that wants a lightweight, yet durable power volleyball system will be pleased with this balance of features and affordability. The unique 42" to 96" infinite height adjustment allows competition power volleyball and PE tennis with the same system.



Steel

VB2000 Centerline® Elite Steel Hybrid

For some programs, set up and tear down is not a common occurrence so the superior rigidity and relative cost advantage of steel makes perfect sense. Despite technical advances in recent years, telescoping steel systems are still the choice of a large number of programs.



Portable

VB8100JR Arena™ JR Freestanding Portable

Use the same pole system in gyms with floor sockets and on floors without sockets. These innovative base units are compatible with 3", 3½" or 4" Bison posts or any other manufacturer's competition posts. Arena JR will maximize your volleyball equipment investment.

	CarbonLite VB7222	CarbonMax VB7000	Centerline Carbon Hybrid VB7777	Lady CarbonMax VB3000	Centerline Aluminum VB1000	Centerline Steel Hybrid VB2000	
Post Material	Carbon Fiber	Carbon Fiber	Carbon Fiber	Carbon Fiber	Aluminum	Steel/Aluminum	
Post Diameter	3"	3½" above floor	3½" above floor	3½" above floor	3"	3"	
Socket Diameter	3"	3"	3"	3"	3"	3"	
Post Weight w/o Winch	16#	32#	27#	19#	34#	61#	
Post Weight w/Winch	21#	37#	32#	24#	39#	66#	
Net Height Range (Approx.)	72" to 98"	78" to 98"	72" to 98"	87" to 89"	72" to 98"	72" to 98"	
Net Height Adjustment	Telescoping	Internal Lead Screw	Spring Assisted Telescoping	Foot Pad Only	Spring Assisted Telescoping	Spring Assisted Telescoping	
Approx. Deflection*	1.50"	.98"	1.87"	1.25"	1.97"	1.25"	
Side-by-Side Option Available	Yes	Yes	Yes	Yes	Yes	Yes	
Post/Winch Warranty	Lifetime Limited	Lifetime Limited	Lifetime Limited	Lifetime Limited	Lifetime Limited	Lifetime Limited	
Outer Post Finish	Clear Resin	Clear Resin	Clear Resin	Clear Resin	Silver Vein Powder Coated	Silver Vein Powder Coated	
Relative Cost	\$\$\$\$	\$\$\$\$\$	\$\$\$\$	\$\$\$\$	\$\$\$	\$\$	

*Compare to some popular aluminum systems with 3"+ of deflection.



When it's time to purchase your next volleyball standards, don't make your selection on brand name recognition alone or you may overlook the best system for your site. Consider the following design features and you are sure to have a system you will be satisfied with for years.

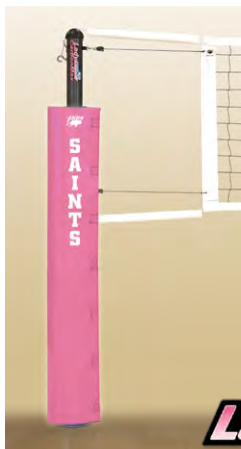

Carbon Fiber

VB3000 Lady CarbonMax™

Lady CarbonMax is the best choice for facilities or programs that play exclusively at official women's height. This system is super lightweight but has the stiffness of a heavy steel system so set up is quick, easy and perfect every time.



Carbon Fiber/Aluminum

VB7777 Centerline® Elite Carbon Hybrid

Even lighter and more rigid than our popular Centerline Aluminum System. Carbon fiber volleyball systems have gained popularity at all levels and this is our most affordable carbon fiber system, offering all the features of the CarbonMax system except for the internal net height winder.

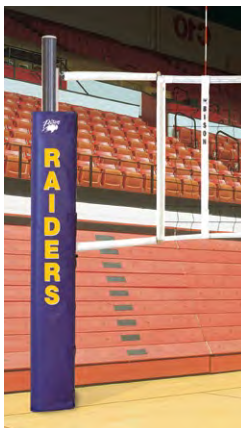

Aluminum

VB9000 UltraLite™ Aluminum

For programs who desire the versatility of easy tennis-to-volleyball net height adjustment and fast and foolproof net set up but demand elite volleyball net tensioning. Especially appealing to programs that have existing 4" floor sleeves because there's no need to install 3" or 3½" adapters.



Aluminum

VB4000 Centerline® Magic™ Self-Storing Volleyball System

This one of a kind system takes self storing to a new level, no wobbling overhead swing ups, and no 8' deep floor wells. Centerline Magic is perfect for new construction but can easily be retrofitted into existing gym floors. You'll never have to worry about transporting or storing your volleyball posts again.

Portable

VB8100 Arena II™ Freestanding Portable

Large arenas and multi-use facilities where elite level volleyball is played but where floor sockets or anchors are difficult, expensive or impossible due to ice rink refrigerant lines, portable flooring systems, upper floor location or other constraints will find this system their best option.



Portable

VB8200/VB8250 QwikCourt™ Portable

Bison's lowest cost self-contained portable volleyball base system. Perfect for use where socket installation is not feasible but an affordable competition or recreational volleyball system is needed for long term or temporary use. Bases can be used with virtually any post system.



Match Point Aluminum VB6000	Centerline Magic VB4000	UltraLite Aluminum VB9000	Arena II Portable VB8100	Arena JR Portable VB8100JR	QwikCourt VB8200 VB8250	Centerline Portable VB1000T	Match Point Portable VB6000T
Aluminum	Aluminum	Aluminum	Steel	Steel	Aluminum	Aluminum	Aluminum
3½"	N/A	4"	3"	3"	3"	3"	3½"
3½"	4½" Integrated	4"	N/A	3", 3½", 4"	N/A	N/A	N/A
39#	N/A	31#	N/A	N/A	N/A	N/A	N/A
43#	N/A	39#	N/A	N/A	N/A	N/A	N/A
42" to 96"	42" to 96"	42" to 96"	80" to 98"	84" to 98"	72" to 98"	82" to 98"	72" to 96"
Slider Bar	Air Cushioned Telescoping	Sliding Track	Spring Assisted Telescoping	Spring Assisted Telescoping	Spring Assisted Telescoping	Spring Assisted Telescoping	Slider Bar
2.81"	1.75"	2.50"	.50"	1.25"	2.00"	1.25"	2.75"
Yes	Yes	Yes	Yes	Yes	No	No	No
10-Year Limited	5-Year Limited	Lifetime Limited	Lifetime Limited	Lifetime Limited	Lifetime Limited	Lifetime Limited	10-Year Limited
Silver Vein Powder Coated	Hard Anodized	Silver Vein Powder Coated	Silver Vein Powder Coated	Silver Vein Powder Coated	Silver Vein Powder Coated	Silver Vein Powder Coated	Silver Vein Powder Coated
\$	\$\$\$\$	\$\$\$\$	\$\$\$\$\$\$	\$\$\$\$		\$\$\$	\$\$





WHY BISON VOLLEYBALL?



Lifetime Warranty Winch*



Permanent Machined Mens, Womens, Jr. Height Markings*



Floor Friendly Adjustable Feet*



Net Rope Top Dome*



Kevlar Top Rope Net

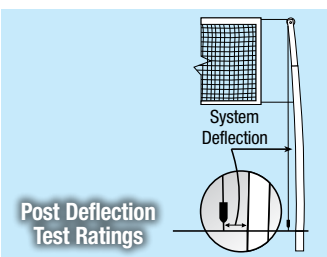

Post Deflection Test Ratings

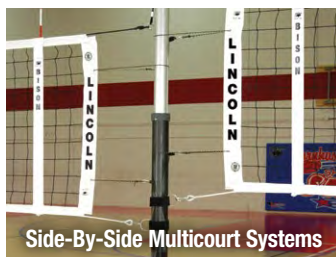

Side-By-Side Multicourt Systems



Rope Ratchet Side Tape Net Tensioners



FREE Post Pad Lettering

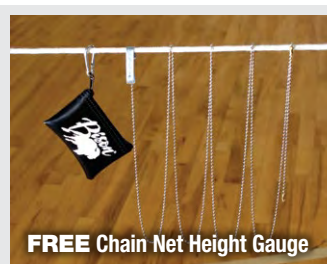

FREE Chain Net Height Gauge



FREE Net Storage Bag



FREE Net Rope Cable Covers

How to Select Your Next Volleyball System

Floor Attachment Most programs want the convenience of posts that drop into floor sockets permanently mounted in the floor. Some gymnasiums, such as upper level gyms, facilities with portable floors or ice refrigerant lines in the sub floor, however, are difficult if not impossible to fit with floor sockets. In these cases, portables that only require floor anchors might be preferable. Truly portable systems (no floor anchoring) are available and generally have a higher price tag and/or require significantly more set up effort.

Post Weight In recent years, lightweight aluminum posts have gained popularity due to their ease of set up and storage. Some buyers have, however, become disenchanted with their aluminum systems due to lack of durability and rigidity. The value of lightweight posts will depend upon how often you set up and tear down your equipment and, in the case of many manufacturers, your tolerance for excess post deflection when the net is tensioned. Some aluminum systems outperform those from other manufacturers. The newest technology available uses carbon fiber to achieve **lighter than aluminum, as stiff as steel** results.

Deflection For ideal playability, the top rope of a competition net is usually tensioned between 150# and 250#, depending on the system. This tension causes some inward deflection of even the most rigid steel posts. Excessive deflection makes net tensioning and net height adjustment difficult and results in unsightly bent posts. Choose a system that you feel balances weight, features and deflection. Steel and carbon fiber posts are most rigid. Aluminum posts are less rigid and deflection varies greatly from manufacturer to manufacturer.

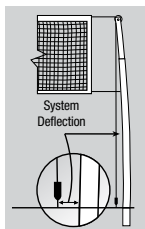

Program Level Your needs will vary depending upon the intended level of play. Systems with telescoping net height adjustment, where the top of the net is always level with the top of the posts, are most popular with collegiate and elite high school programs. Other systems that offer features like tennis to volleyball height adjustment are common for programs that want to use the same systems for competition power volleyball one day and recreation and physical education classes the next. Generally these systems offer not only versatility but also tight budget affordability.

Post Size If you are installing a new system including floor sockets, the size of the selected posts will automatically match your new sockets. Retrofitting new systems into existing sockets, however, requires purchasing posts to match your sockets. There are three competition sizes in the industry: 3", 3½" and 4" (100mm). Most manufacturers offer adapters which allow you to put smaller posts into bigger sockets. Some are free, others are an additional cost. Installation of large posts in small sockets is possible but not ideal. Check with the manufacturer before you buy. Totally replacing existing sockets is an undesirable and expensive option in most cases.

Transport and Storage In a perfect world, you would snap your fingers and your volleyball system would magically appear. While it's not a perfect world, your equipment selection will, in large part, determine your future set up time and efforts. For many programs, Bison's Centerline Magic self-storing system is the answer. If you are selecting from the wide range of other transportable pole systems, consider issues such as pole weight, available storage and transport dollies to make the best decision for your program.

Budget There is a wide range of systems that meet all applicable NCAA, National High School Federation and USVBA rules. Like any equipment, the amount you wish to spend depends upon your budget and the features your program needs. Generally, you pay more for the convenience of lightweight aluminum. New high tech carbon fiber systems are priced above aluminum but have many additional features including superior resistance to deflection.

Post Padding Most programs want padding to match their school or facility colors. Some manufacturers offer limited colors or charge extra for expanded color options. Adding lettering to the padding is now very popular as it helps increase school spirit and improves the look of your courts. By and large, stick-on vinyl letters are not a good long-term lettering option as they will curl over time.

Most complete Bison systems ordered offer printed lettering at no extra charge.

Warranty You'll want to know that the manufacturer will stand behind the product in the event of needed repairs or part replacement. Look for written warranties and buy from manufacturers who have a strong reputation for dependable customer service. Most often, the net tensioning winch is the weak link so winch durability usually indicates system durability. **Purchasing through a local dealer is not only friendly to the local economy but improves your service when you need help.**

*on most systems



CarbonLite™ 

NEW!

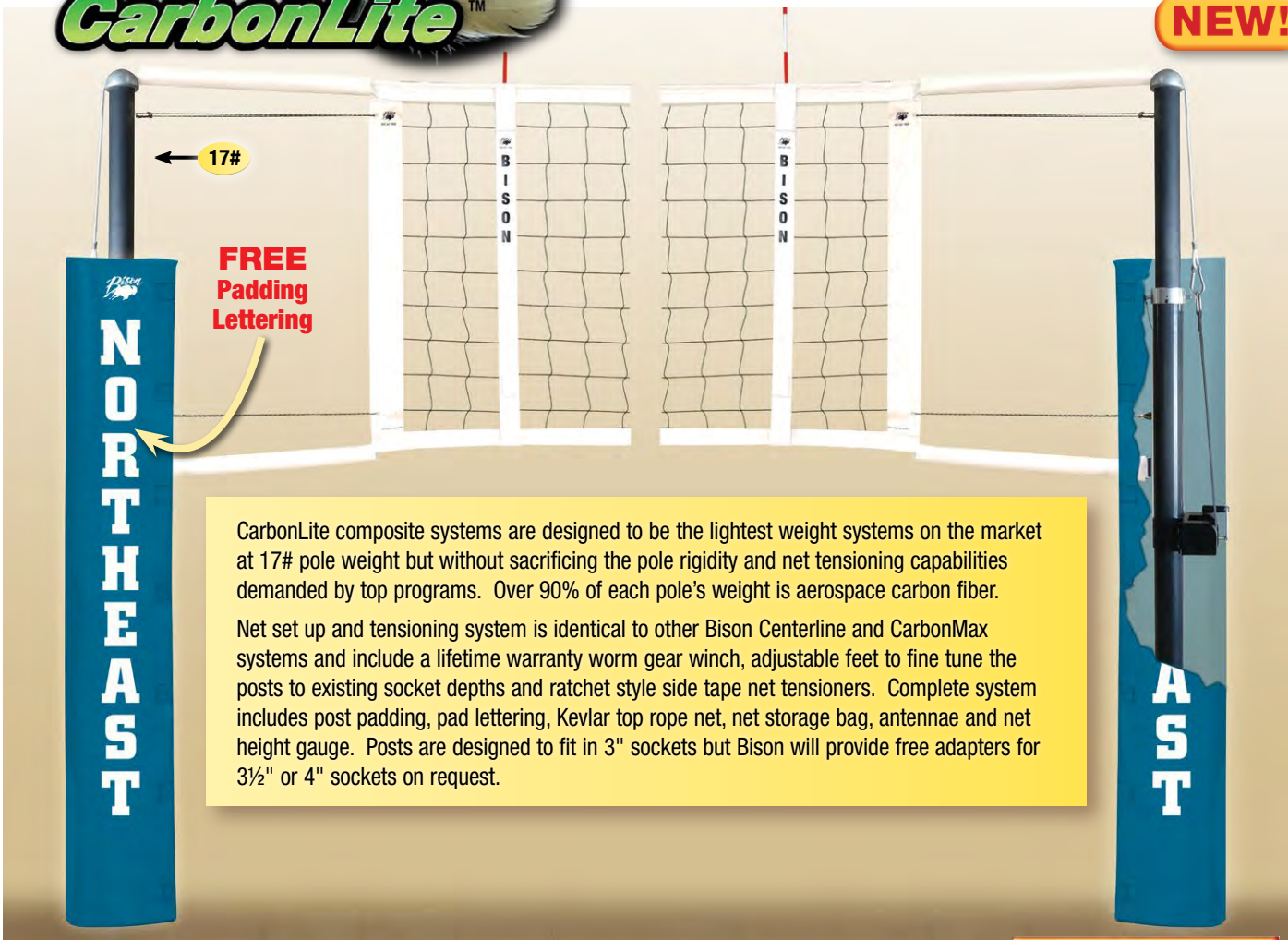

CarbonLite composite systems are designed to be the lightest weight systems on the market at 17# pole weight but without sacrificing the pole rigidity and net tensioning capabilities demanded by top programs. Over 90% of each pole's weight is aerospace carbon fiber.

Net set up and tensioning system is identical to other Bison Centerline and CarbonMax systems and include a lifetime warranty worm gear winch, adjustable feet to fine tune the posts to existing socket depths and ratchet style side tape net tensioners. Complete system includes post padding, pad lettering, Kevlar top rope net, net storage bag, antennae and net height gauge. Posts are designed to fit in 3" sockets but Bison will provide free adapters for 3½" or 4" sockets on request.

VB7222 Shown with Free ABC52 Lettering

VB7222 CarbonLite® Composite System

Aerospace carbon fiber and lots of it... Cmake this 3" diameter system the perfect blend of ease of transport and set up and ideal consistent net tension • Combination of staggered pin stops and adjustable lower feet allow the net to be positioned easily at Men's, Women's or Junior heights and anywhere in between • Net tensioning is accomplished using Bison's lifetime warranty machined worm gear winch combined with rope ratchet side tape and bottom rope tensioner • Complete system includes posts, winch, post padding with free lettering, rope covers, Kevlar net with storage bag, antennae and chain net height gauge • See chart below for various packages and individual post components • Order official stand separately • Post weight on non-winch end 17#, winch end 22#.

Common Applications

VB7222

CarbonLite® Composite

The lightest weight competition volleyball system in the industry making it perfect for facilities where set up and tear down is frequent. The 3" outer post and telescoping inner pole are computer wound for maximum net tensioning despite the low weight to pole rigidity ratio.



Permanent Height Markings

Complete Systems Include FREE Chain Net Height Gauge, Net Storage Bag and Lettered Post Padding!

CarbonLite Model Order #	Approx. Shipping Weight	Description	Free Pad Lettering
VB7222	120#, Truck	Complete system described above.	Yes
VB7222NS	110#, Truck	Same as VB7222 with exclusion of VB23 floor sockets.	Yes
VB7202	180#, Truck	Complete side-by-side double court system includes three posts, two net tensioning winches, three VB23 floor sockets, three post pads with lettering, two nets, two sets of antennae and rope covers.	Yes
VB7202NS	165#, Truck	Same system as VB7202 above with exclusion of VB23 floor sockets.	Yes
VB72	65#, Truck	Posts and net tensioning winch only. Order net, padding, antennae and floor sockets separately.	No
VB722	25#, Truck	Court adder increases the number of side-by-side courts and includes post and net tensioning winch. Order other components separately. Call for details.	No



See back cover for details.





Centerline Elite Carbon Hybrid Systems are the latest additions to our innovative volleyball system offering. The combination of the wound carbon fiber outer (lower) pole and aircraft quality aluminum inner (upper) pole make this system the lightest weight version of our popular easy to set up Centerline Elite Series.

Just like other Centerline Elite systems, these include lifetime warranty worm gear winch, floor friendly adjustable foot pads, high visibility net height markings and free features including post pad, lettering, chain style net height check gauge, lettered side tape covers, net storage bag and adapters to allow use in 3 1/2" or 4" sockets in addition to popular 3" floor sockets

Common Applications

VB7777 Shown with Free ABC52 Lettering

VB7777

Carbon Hybrid

Even lighter and more rigid than our popular Centerline Aluminum System, carbon fiber volleyball systems have gained popularity at all levels and this is our most affordable carbon fiber system, offering all the features of the CarbonMax system except for the internal net height winder.

VB7777 Carbon Hybrid Composite System

Enjoy the benefits of lightweight carbon fiber technology...at a cost that may surprise you • Same great features found in our popular Centerline series of volleyball systems for elite level play • Net height setting and adjustment is accomplished by three design features • Use pin stops for Men's, Women's and Junior heights • Use the infinitely variable adjustment knob to set at other heights • Use the adjustable floor foot to fine tune height settings to match your floor socket installation depth • Post fits in all brands of 3" floor sockets but can be used in 3 1/2" or 4" sockets • **Free socket adapters available on request with purchase of complete system** • Complete systems include posts, net, antennae, post padding, net rope covers • Systems also include free post padding lettering, chain net height gauge, and net storage bag • See chart below for various packages and individual post components • Order official's stand separately • **Lifetime limited warranty** on posts and winch. Post weight for non winch end 27#; winch end 32#. Approx. shipping weight 140#, Truck

Complete Systems Include FREE Chain Net Height Gauge, Net Storage Bag and Lettered Post Padding!

Centerline Carbon Hybrid Model Order #	Approx. Shipping Weight	Description	Free Pad Lettering
VB7777	140#, Truck	Complete system described above.	Yes
VB7777NS	130#, Truck	Same as VB7777 above with exclusion of VB23 floor sockets.	Yes
VB7702	210#, Truck	Complete side-by-side double court system includes three posts, two net tensioning winches, three VB23 floor sockets, three post pads, two nets, two sets of antennae and rope covers.	Yes
VB7702NS	195#, Truck	Same system as VB77772 above with exclusion of VB23 floor sockets.	Yes
VB77	85#, Truck	Posts and net tensioning winch only. Order net, padding, antennae, and floor sockets separately.	No
VB777	45#, Truck	Court adder increases the number of side-by-side courts and includes post and net tensioning winch. Order other components separately. Call for details.	No





Graphite composite has long been the preferred material for lightweight yet strong sports equipment including tennis rackets, golf club shafts, racing bicycle frames and a wide variety of other products where traditional materials have not provided the performance desired by athletes. Bison has worked with composite engineers to develop a wound carbon fiber tube that maximizes rigidity and minimizes weight. CarbonMax is truly **lighter than aluminum and as rigid as steel.**

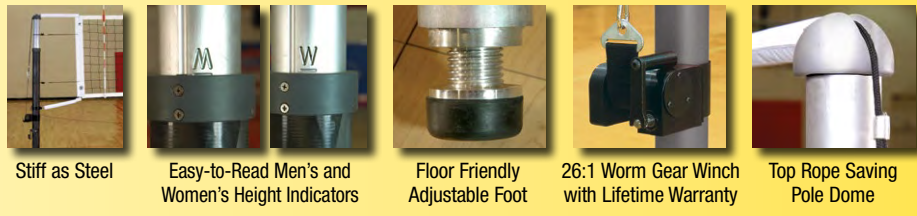

VB7000 Shown with Free ABC52 Lettering

Common Applications

VB7000

CarbonMax® Composite

Elite programs that want a super lightweight, easy to set up system with easy windup net height adjustment but are not willing to sacrifice rigidity and superior net tensioning will discover this is the best system on the market today. Carbon fiber is an investment in the latest volleyball technology.

VB7000 CarbonMax® Composite System

Maximum rigidity, maximum convenience, maximum overall performance and maximum satisfaction... Carbon fiber 3½" outer posts with 3" tempered aluminum floor socket stem and inner extension tube for rigidity and durability • **Lighter than aluminum design** and windup internal net height adjustment maximize fast, easy and convenient set up and teardown • 26:1 worm gear winch and knotless mesh net with Kevlar top rope maximize net tension performance • 40% less deflection than even Centerline Elite Aluminum Systems, as much as 60% less deflection than popular aluminum systems from other manufacturers • Internal net height adjuster has a durable ¾" diameter lead screw for easy net height adjustment even when the net is tensioned • Safety padding includes lettering (up to 10 letters on all four sides) • See page 102 for color options • **Adapters for installation into existing 3½" or 4" floor sockets are free on request with purchase of complete system** • Other features include premium Centerline antennae, net rope covers and 78" to 98" net height adjustment for all levels of play • Entire system meets NCAA, National High School Federation and USVBA rules • Order VB73 or VB76 padded official's stand separately • Complete competition system includes posts, net tensioning winch, VB1250K net, net storage bag, VB13 antennae, VB51P safety padding, post padding lettering, net rope covers, VB23 floor sockets • **Lifetime limited warranty** on posts and winch. Post weight for non-winch end 32#; winch end 37#. Approx. shipping weight: 150#; Truck

Complete Systems Include FREE Chain Net Height Gauge, Net Storage Bag and Lettered Post Padding!

CarbonMax Model Order #	Approx. Shipping Weight	Description	Free Pad Lettering
VB7000	150#, Truck	Complete system described above.	Yes
VB7000NS	130#, Truck	Same as VB7000 with exclusion of VB23 floor sockets.	Yes
VB7002	230#, Truck	Complete side-by-side double court system includes three posts, two net tensioning winches, three VB23 floor sockets, three post pads, two nets, two sets of antennae and rope covers.	Yes
VB7002NS	210#, Truck	Same system as VB7002 with exclusion of VB23 floor sockets.	Yes
VB70	95#, Truck	Posts and net tensioning winch only. Order net, padding, antennae and floor sockets separately.	No
VB700	50#, Truck	Court adder increases the number of side-by-side courts and includes post and net tensioning winch. Order other components separately. Call for details.	No

"Our Division I program is a perennial National Championship contender, and we work hard to provide our players with superior equipment. As a longtime user of Bison Centerline Elite Aluminum Systems, we thought we had the best...that was until we discovered CarbonMax. Our equipment manager loves the lightweight design that doesn't compromise on rigidity. The ability to adjust the net height with the turn of a crank without loosening the net is an added bonus."

John Cook
Head Women's Volleyball Coach
University of Nebraska
2006 NCAA Division I Champions





Lady CarbonMax

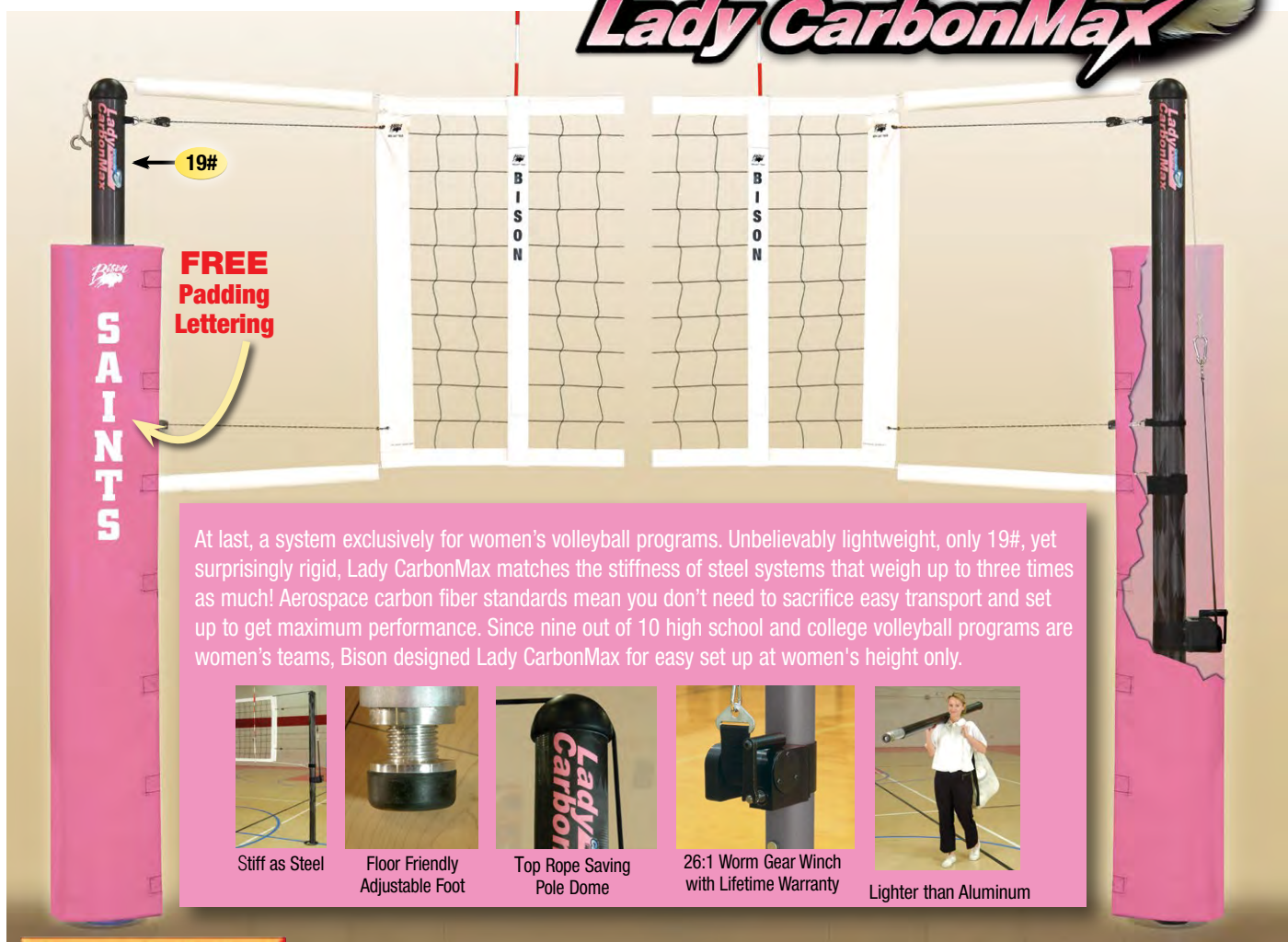

At last, a system exclusively for women's volleyball programs. Unbelievably lightweight, only 19#, yet surprisingly rigid, Lady CarbonMax matches the stiffness of steel systems that weigh up to three times as much! Aerospace carbon fiber standards mean you don't need to sacrifice easy transport and set up to get maximum performance. Since nine out of 10 high school and college volleyball programs are women's teams, Bison designed Lady CarbonMax for easy set up at women's height only.



Stiff as Steel



Floor Friendly Adjustable Foot



Top Rope Saving Pole Dome



26:1 Worm Gear Winch with Lifetime Warranty



Lighter than Aluminum

Common Applications

VB3000 Shown with Free ABC52 Lettering on NEW VB51P-PK Post Padding

VB3000 Lady CarbonMax® Composite

Lady CarbonMax is the best choice for facilities or programs that play exclusively at official women's height. This system is super lightweight but has the stiffness of a heavy steel system so set up is quick, easy and perfect every time.

VB3000 Lady CarbonMax® Composite System

Light as a feather yet performance that equals that of heavy steel systems... Set up is fast, easy and perfect every time, no need for net height gauges because this system is designed specifically for set up at official 7' 4 1/8" (2.24 meters) women's height only • The below-the-floor fine tuning height adjustment features allow Lady CarbonMax to be field adjusted when the system is first installed • Fits in any brand of 3" or larger floor socket • **If your existing sockets are 3 1/2" or 4", Bison will provide socket adapters at no extra charge on request with purchase of complete system** • The 3 1/2" high tech carbon fiber pole is fitted with a 3" tempered aluminum floor socket stem • Even at 19# (non-winch end), the post rigidity far exceeds any aluminum system on the market and equals that of steel posts that weigh as much as 60# • 26:1 lifetime warranty worm gear winch, Kevlar top rope net and unique rope ratchet side tape tensioners create the net tension preferred by elite players and coaches • Safety padding includes lettering (up to 10 letters on all 4 sides), see page 102 for color options • Complete package includes standards, winch, VB1250K Kevlar net, net storage bag, VB13 antennae, safety padding, post pad lettering, net rope covers and VB23 floor sockets • Entire system meets all NCAA, National High School Federation and USVBA rules • Order VB73 or VB76 official's stand separately • **Lifetime limited warranty** on posts and winch. Post weight for non-winch end 19#, winch end 24#. Approx. shipping weight 120#, Truck

Complete Systems Include FREE Chain Net Height Gauge, Net Storage Bag and Lettered Post Padding!

Lady CarbonMax Model Order #	Approx. Shipping Weight	Description	Free Pad Lettering
VB3000	120#, Truck	Complete system described above.	Yes
VB3000NS	105#, Truck	Same as VB3000 with exclusion of VB23 floor sockets.	Yes
VB3002	195#, Truck	Complete side-by-side double court system includes three posts, two net tensioning winches, three VB23 floor sockets, three post pads, two nets, two sets of antennae and rope covers.	Yes
VB3002NS	175#, Truck	Same system as VB3002 with exclusion of VB23 floor sockets.	Yes
VB30	65#, Truck	Posts and net tensioning winch only. Order net, padding, antennae and floor sockets separately.	No
VB300	40#, Truck	Court adder increases the number of side-by-side courts and includes post and net tensioning winch. Order other components separately. Call for details.	No

"Our volleyball coach loves Bison's Lady CarbonMax composite volleyball system. We've used this system for a few seasons now and are pleased with its trouble-free performance. The standards are very easy to set up, they're lightweight and dependable."

Bill Clements
Activities Director
Dakota Valley High School
North Sioux City, SD



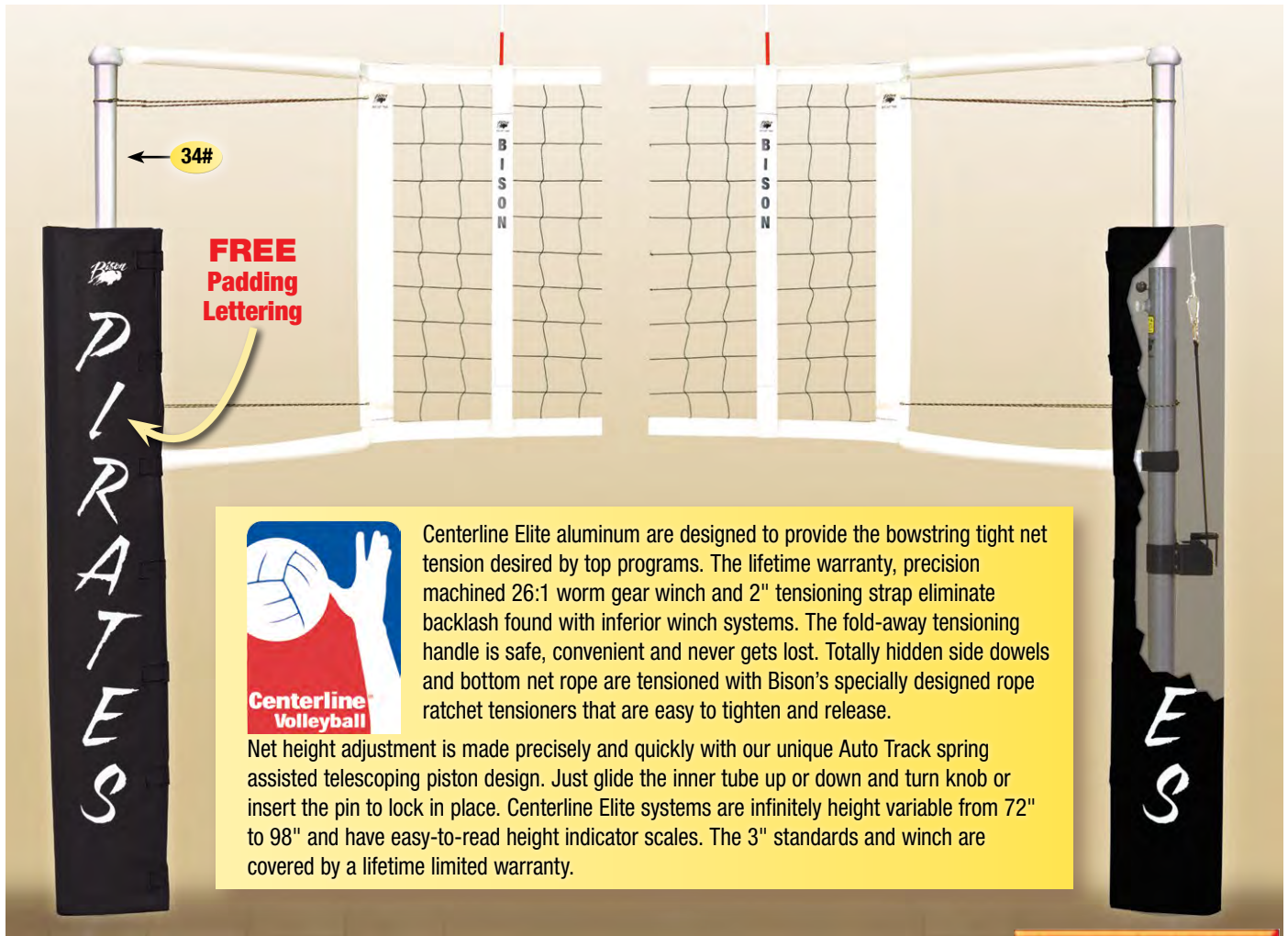

Centerline Volleyball

Centerline Elite aluminum are designed to provide the bowstring tight net tension desired by top programs. The lifetime warranty, precision machined 26:1 worm gear winch and 2" tensioning strap eliminate backlash found with inferior winch systems. The fold-away tensioning handle is safe, convenient and never gets lost. Totally hidden side dowels and bottom net rope are tensioned with Bison's specially designed rope ratchet tensioners that are easy to tighten and release.

Net height adjustment is made precisely and quickly with our unique Auto Track spring assisted telescoping piston design. Just glide the inner tube up or down and turn knob or insert the pin to lock in place. Centerline Elite systems are infinitely height variable from 72" to 98" and have easy-to-read height indicator scales. The 3" standards and winch are covered by a lifetime limited warranty.

VB1000 Shown with Free ABC52 Lettering

Common Applications

VB1000

Centerline® Elite Aluminum

Division I and premier high school programs that desire the advantages of lightweight aluminum but are concerned about excessive deflection and net tensioning problems common with other aluminum systems are the most common buyers of this system.

VB1000 Centerline® Elite Aluminum System

Power volleyball at the highest level demands equipment to match... Centerline Elite Aluminum is used in top collegiate programs across the country and is designed for years of dependable use and quick, easy and bowstring tight set up • Aluminum systems have gained in popularity due to their lightweight handling for installation and removal • With Centerline Elite Aluminum standards, you don't sacrifice rigidity to get lightweight convenience • These custom extrusions put high strength, lightweight aluminum where it matters most to decrease post deflection as much as 30% over other well-known aluminum systems • Outer pole has durable powder coated finish • Complete competition system includes posts, net tensioning winch, VB1250K net, VB13 antennae, VB51P safety padding (choose from colors shown on page 102), net rope covers and VB23 floor sockets • **Free socket adapters on request with purchase of complete system** • Order VB73 or VB76 official's platform separately • See note below for 17/8" socket compatibility • **Lifetime limited warranty** on posts and winch. Post weight for non-winch end 34#; winch end 39#. Approx. shipping weight: 145#; Truck.

Complete Systems Include FREE Chain Net Height Gauge, Net Storage Bag and Lettered Post Padding!

Centerline Aluminum Model Order #	Approx. Shipping Weight	Description	Free Pad Lettering
VB1000	145#, Truck	Complete system described above.	Yes
VB1000NS	130#, Truck	Same as VB1000 with exclusion of VB23 floor sockets.	Yes
VB1002	230#, Truck	Complete side-by-side double court system includes three posts, two net tensioning winches, three VB23 floor sockets, three post pads, two nets, two sets of antennae and rope covers.	Yes
VB1002NS	210#, Truck	Same system as VB1002 with exclusion of VB23 floor sockets.	Yes
VB10	95#, Truck	Posts and net tensioning winch only. Order net, padding, antennae and floor sockets separately.	No
VB100	50#, Truck	Court adder increases the number of side-by-side courts and includes post and net tensioning winch. Order other components separately. Call for details.	No

"Steel is great in cars or buildings, but when the University of Arizona volleyball team practices in the Wildcats basketball arena, we got tired of hauling the heavy systems in and out. I'd never considered aluminum systems because of negative comments from other coaches. I am now a firm believer that weight alone is not the measure of a quality volleyball system. While Centerline Elite aluminum standards won't make our team better, it has made our equipment managers happier."

Dave Rubio
Head Women's Volleyball Coach,
University of Arizona



NOTE: For use with 17/8" floor sockets common in Canada and other markets, contact a Bison Specialist for details.

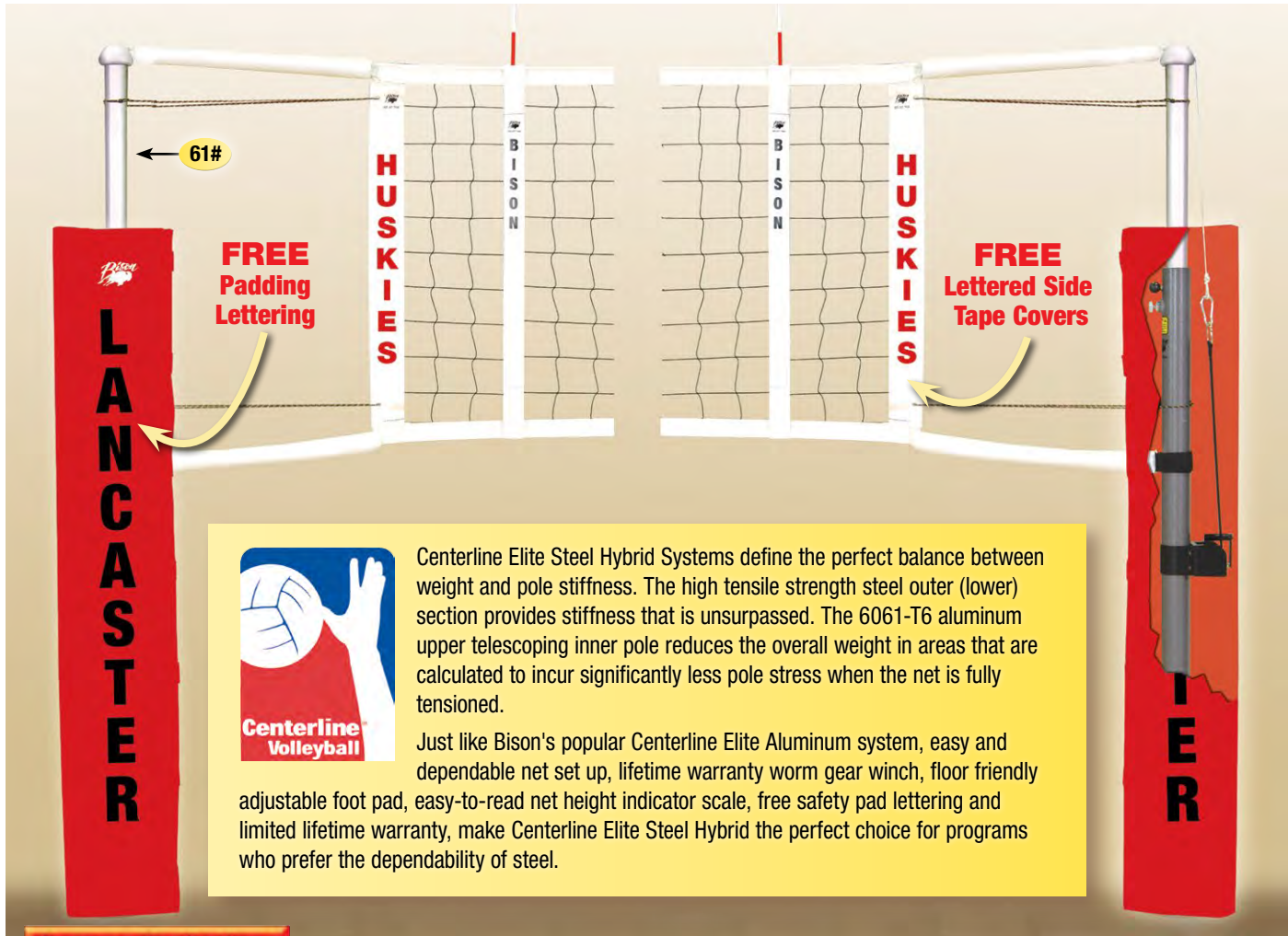

Centerline Elite Steel Hybrid Systems define the perfect balance between weight and pole stiffness. The high tensile strength steel outer (lower) section provides stiffness that is unsurpassed. The 6061-T6 aluminum upper telescoping inner pole reduces the overall weight in areas that are calculated to incur significantly less pole stress when the net is fully tensioned.

Just like Bison's popular Centerline Elite Aluminum system, easy and dependable net set up, lifetime warranty worm gear winch, floor friendly adjustable foot pad, easy-to-read net height indicator scale, free safety pad lettering and limited lifetime warranty, make Centerline Elite Steel Hybrid the perfect choice for programs who prefer the dependability of steel.



Common Applications

VB2000 Shown with Free ABC52 Lettering and VB1250ST Side Tape Covers

VB2000 Centerline® Elite Steel Hybrid

For some programs set up and tear down is not a common occurrence so the superior rigidity and relative cost advantage of steel makes perfect sense. Despite advances in technology in recent years, telescoping steel systems are still the choice of a large number of programs.

VB2000 Centerline® Elite Steel Hybrid

When transport and storage of heavy steel standards is not a concern...Centerline Steel Hybrid is your logical choice • No material can surpass the rigidity and durability of steel and Bison has put high tensile strength steel where it matters most, the lower section of the pole • Only Bison offers a hybrid system that includes a lighter weight aluminum, inner telescoping pole where the forces of net tensioning don't require heavy steel • Outer pole has a durable powder coated finish • Complete competition systems including posts, net tensioning winch, VB1250K net, VB13 antennae, VB51P safety padding (choose from colors shown on page 102), net rope covers and VB23 floor sockets • **Free socket adapters on request with purchase of complete system** • Order VB73 or VB76 officials platform separately • **Lifetime limited warranty** on posts and winch. Post weight for non winch end 61#; winch end 66#. Approx. shipping weight 220#, Truck

Complete Systems Include FREE Chain Net Height Gauge, Net Storage Bag plus Lettered Post Padding and Side Tape Covers!



Order VB73 or VB76 Officials Platform Separately

Centerline Steel Hybrid Model Order #	Approx. Shipping Weight	Description	Free Lettering and Side Tapes
VB2000	220#, Truck	Complete system described above.	Yes
VB2000NS	205#, Truck	Same as VB2000 with exclusion of VB23 floor sockets.	Yes
VB2002	310#, Truck	Complete side-by-side double court system includes three posts, two net tensioning winches, three VB23 floor sockets, three post pads, two nets, two sets of antennae and rope covers.	Yes
VB2002NS	280#, Truck	Same system as VB2002 with exclusion of VB23 floor sockets.	Yes
VB20	150#, Truck	Posts and net tensioning winch only. Order net, padding, antennae and floor sockets separately.	No
VB200	80#, Truck	Court adder increases the number of side-by-side courts and includes post and net tensioning winch. Order other components separately. Call for details.	No





No competition volleyball system on the market offers the features found on the Magic Self-Storing Volleyball System. Just like the name implies, super rigid and durable telescoping poles disappear into a 32" deep floor well that can be installed during gym construction, retrofitted into existing floors or installed as a replacement to existing traditional floor sleeves. Injuries, floor damage and equipment deterioration common when heavy, awkward poles are constantly moved from gym to storage are a thing of the past. Magic set up takes five-minutes maximum and tear down is even faster. The best part is you won't sacrifice durability, post rigidity, net tensioning or stability in exchange for safety and convenience. You can count on Bison to provide you the best volleyball system options in the industry.

US Patent #8,057,329 B2

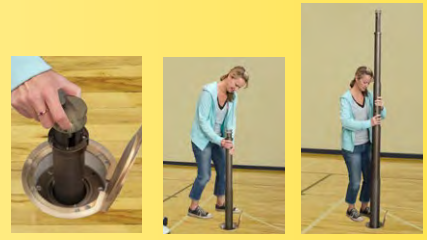

Pole Magically Telescopes from Floor in Five Rigid Sections

VB4000 Shown with Free ABC52 Lettering

VB4000 Magic™ Self-Storing Volleyball System

Now you see it...Now you don't... Never hassle with heavy, awkward or bulky volleyball posts to and from your gym again • Magic is self-storing in a self-contained 32" deep floor well • 5 high tensile, hard coated aluminum telescoping tubes lift easily from the floor sleeve • When extended for setup, each tubular section twists to lock into place • When lowered into well for storage, sectional tubes slowly recede into the tube below due to a patent pending air cushioning design to eliminate pinched finger or sudden pole retraction • Net height is infinitely adjustable to any net height from 42" to 96" for competition at collegiate or high school men's or women's level one minute and youth PE class the next • Complete Magic system includes telescoping self-storing poles with floor well (sleeve), VB23-CV brass floating floor plates, VB1250K net with zippered net storage bag, VB13 antennae/boundary markers, post padding (choose from colors shown on page 102), free pad lettering, net height chain gauge and lifetime warranty 26:1 worm gear winch • Magic meets or exceeds all NCAA, National High School Federation and USVBA rules for play at all levels • Order VB73 or VB76 padded officials stand separately • **Lifetime limited warranty** on winch • 5 year repair or replacement warranty on telescoping posts. Approx. shipping weight: 125#, Sm. Pkg.



Fingertip Net Height Control Telescoping Spring Release

Common Applications

VB4000 Magic™ Self-Storing
This one of a kind system takes self-storing to a new level, no wobbling overhead swing ups, and no 8' deep floor wells. Magic is perfect for new construction but can easily be retrofitted into existing gym floors. You'll never have to worry about transporting or storing your volleyball posts again.

Complete Systems Include FREE Chain Net Height Gauge, Net Storage Bag and Lettered Post Padding!

Magic Model Order #	Approx. Shipping Weight	Description	Free Pad Lettering
VB4000	125#, Truck	Complete system described above.	Yes
VB4002	185#, Truck	Complete side-by-side double court system includes three posts, two net tensioning winches, three VB23-CV brass floor plates, three post pads, two nets, two sets of antennae and rope covers.	Yes
VB40	100#, Truck	Posts and net tensioning winch only. Order net, padding, antennae and VB23-CV brass floor plates separately.	No
VB400	50#, Truck	Court adder increases the number of side-by-side courts and includes post and net tensioning winch. Order other components separately. Call for details.	No

"The storage room for our volleyball equipment was located on the second floor above the gym. I always held my breath as my players carried heavy poles up and down the steep stairs before and after each practice. So much time was wasted setting up and taking down. Bison self-storing poles are ingenious! It literally takes only minutes to set up the nets. They are designed for optimum performance and safety. I have used four different manufacturers' volleyball systems during my eight years of coaching club and high school, and it has been a relief to use the Magic volleyball system!"

Lynette Gustafson
Volleyball Coach
Woodland Park, CO



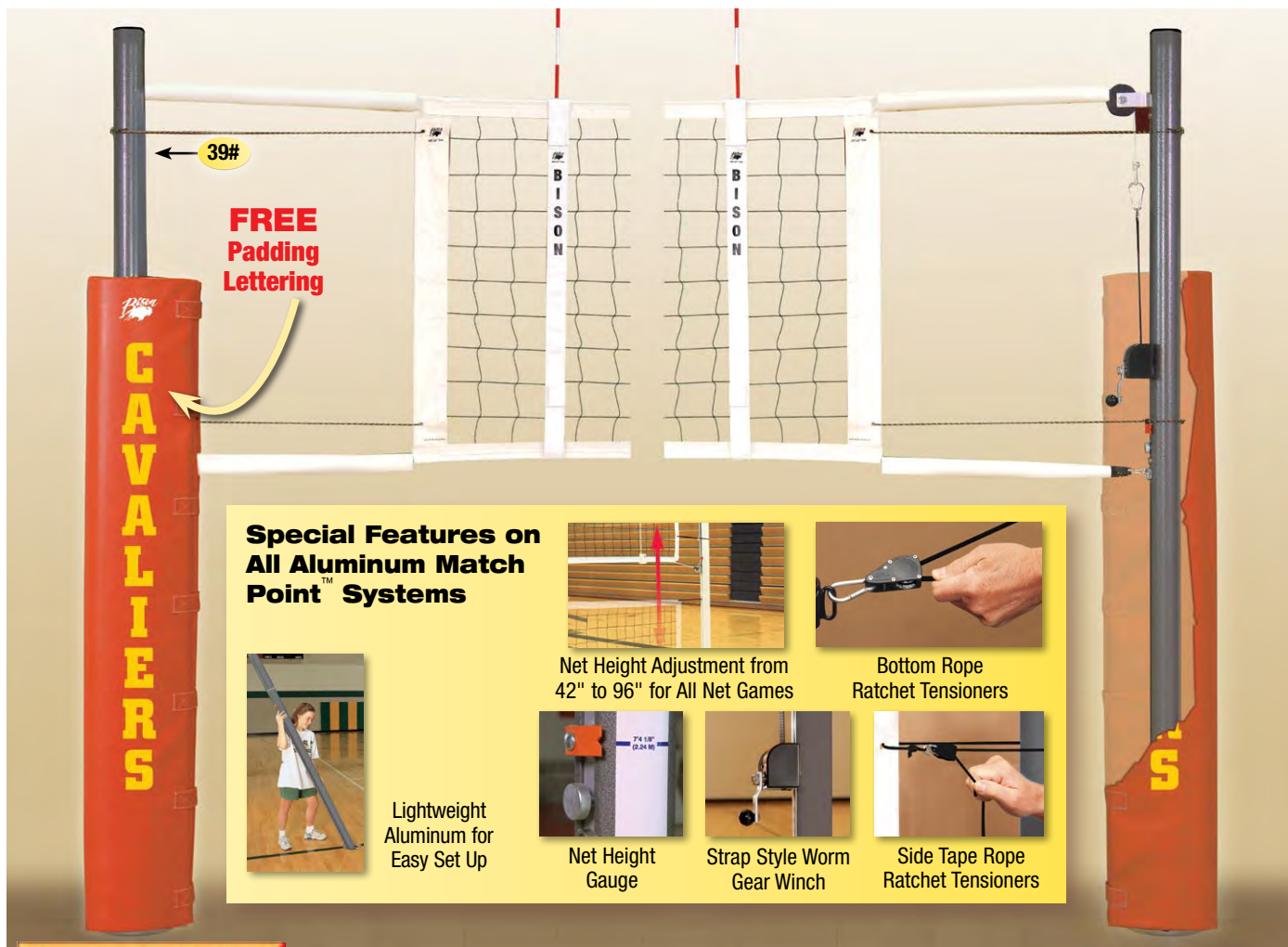

Special Features on All Aluminum Match Point™ Systems

Net Height Adjustment from 42" to 96" for All Net Games

Bottom Rope Ratchet Tensioners

Net Height Gauge

Strap Style Worm Gear Winch

Side Tape Rope Ratchet Tensioners

Lightweight Aluminum for Easy Set Up

Common Applications

VB6000 Match Point™ Aluminum

High schools on a budget, recreation centers and any facility that wants a lightweight, yet durable power volleyball system will be pleased with this balance of features and affordability. The unique 42" to 96" infinite height adjustment allows competition power volleyball and PE tennis with the same system.

VB6000 Match Point™ Aluminum System

Maximum versatility, maximum value, maximum convenience, lightweight, yet rigid aluminum... Standards are specially designed, heavy wall aluminum extrusions • Order packages complete with net, post padding and boundary antennae or order components separately • Superior net tensioning for the ball rebound preferred by players and coaches • Backlash-free worm gear top rope tensioner • Easy-to read height indicators on both posts • Adjust net height from 42" to 96" for all levels of competition volleyball play plus tennis, badminton, pickleball and other net games • Choose complete package including floor sockets and hinged brass floor plates for new construction or package without sockets to replace system in existing 3½" or 4" sockets • Bison will provide, at no cost, adapters for installation of these 3½" standards in 4" existing sockets, call for assistance • Meets all NCAA, USVBA and National High School Federation rules • Durable powder coated finish • 1" thick post padding protects to 6' height, see page 102 for color options • Order VB76 padded official's stand separately • Complete competition system includes posts, net tensioning winch, VB1250K net, VB13 antennae, VB51P safety padding and VB26 floor sockets • **Free socket adapters on request with purchase of complete system** • 10-year limited warranty on posts and winch. Post weight for non-winch end 39#; winch end 43#. Approx. shipping weight: 170#; Truck

Complete Systems Include FREE Chain Net Height Gauge, Net Storage Bag and Lettered Post Padding!

VB6000 Shown with Free ABC52 Lettering

Match Point Aluminum Model Order #	Approx. Shipping Weight	Description	Free Pad Lettering
VB6000	170#, Truck	Complete system described above.	Yes
VB6000NS	155#, Truck	Same as VB6000 with exclusion of VB26 floor sockets.	Yes
VB6050	145#, Truck	Recreational system includes posts, net tensioning winch, VB1250K net and VB21 economy floor sockets for tile, concrete or synthetic floors. VB26 floating wood floor sockets available at additional cost.	No
VB6050NS	125#, Truck	Same system as VB6050 except excludes floor sockets.	No
VB6002	280#, Truck	Complete side-by-side double court system includes three posts, two net tensioning winches, three VB26 floor sockets, three post pads, two nets and two sets of antennae.	Yes
VB6002NS	260#, Truck	Same system as VB6002 with exclusion of floor sockets.	Yes
VB60	110#, Truck	Posts and net tensioning winch only. Order net, padding, antennae and floor sockets separately.	No
VB600	60#, Truck	Court adder increases the number of side-by-side courts and includes post and net tensioning winch. Order other components separately. Call for details.	No



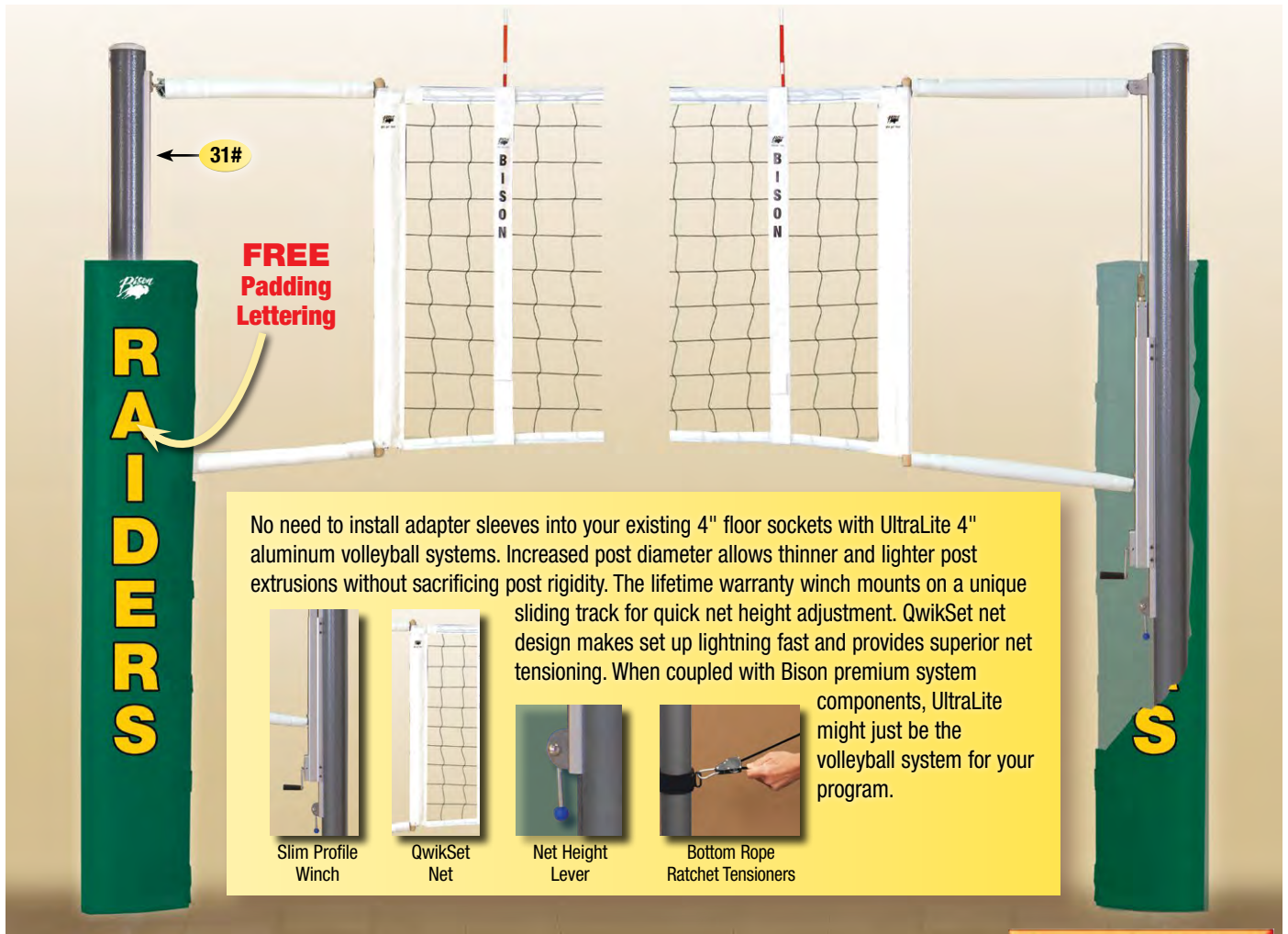

No need to install adapter sleeves into your existing 4" floor sockets with UltraLite 4" aluminum volleyball systems. Increased post diameter allows thinner and lighter post extrusions without sacrificing post rigidity. The lifetime warranty winch mounts on a unique sliding track for quick net height adjustment. QwikSet net design makes set up lightning fast and provides superior net tensioning. When coupled with Bison premium system components, UltraLite might just be the volleyball system for your program.

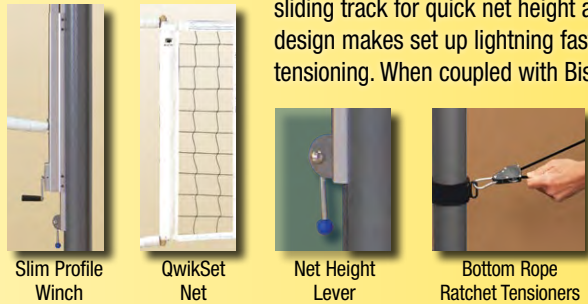

VB9000 Shown with Free ABC52 Lettering Plus Optional ABC53 Second Color Lettering

Common Applications

VB9000 UltraLite™ Aluminum
 For programs who desire the versatility of easy tennis-to-volleyball net height adjustment and fast and foolproof net set up but demand elite volleyball net tensioning. Especially appealing to programs that have existing 4" floor sleeves because there's no need to install 3" or 3½" adapters.

vb9000 UltraLite™ Aluminum System

New from Bison but not new to the industry... Popular, super lightweight 4" diameter posts fit all manufacturers' 4" diameter floor sleeves so there is no need to use adapter sleeves • **Lifetime warranty on posts and winch** proves this is a durable, functional system with a long life • The slimline, high tech, self-lubricating lead screw winch allows maximum tension with minimum effort • QwikSet net attachment system has no loose parts so it sets up consistently in less than five minutes • Net height is variable by a simple flip of a lever, allowing the slide rail to adjust net height from 96" to 42" and every height in between for all levels of volleyball play, badminton, tennis or pickle ball • Set up at tennis height (42") requires special attachment components, call a Bison Product Specialist for details, free components and instructions • Durable powder coated finish • Choose complete system with all components or order components separately • Complete system includes two standards, winch, post padding (choose from colors shown on page 102), net, antennas, net rope covers, net storage bag, padding lettering and VB27 floor sockets • Order VB73 or VB76 volleyball official's platform separately • See chart for ordering information.

Post weight for non-winch end 31#, winch end 39#. Approx. shipping weight: 130#; Truck

Complete Systems Include FREE Chain Net Height Gauge, Net Storage Bag and Lettered Post Padding!

UltraLite Model Order #	Approx. Shipping Weight	Description	Free Pad Lettering
VB9000	130#, Truck	Complete system described above.	Yes
VB9000NS	115#, Truck	Same as VB9000 with exclusion of VB27 floor sockets.	Yes
VB9002	210#, Truck	Complete side-by-side double court system including three posts, two winches, two nets, three post pads, three floor sockets, two sets of antennas and rope covers.	Yes
VB9002NS	190#, Truck	Same system as VB9002 with exclusion of VB27 floor sockets.	Yes
VB90	75#, Truck	Posts and net tensioning winch only. Order net, padding, antennae and floor sockets separately.	No
VB900	50#, Truck	Court adder increases the number of side-by-side courts and includes post and net tensioning winch. Order other components separately. Call for details.	No



See back cover for details.





Until now, facilities where floor sockets or floor anchor systems were difficult, inconvenient or truly impossible to install had limited options when it came to selecting volleyball systems suitable for elite power volleyball.

Unlike other portable units on the market, Arena II needs absolutely no floor anchors and no bulky, heavy, awkward, loose ballasts and extended framework. Unlike ceiling mount swing down systems, there is no custom design, extended delivery, expensive installation or difficult net height adjustment. Arena II is totally self-contained, with built-in ballast that allows superior net tensioning and a 100% guarantee not to slip or slide on any common volleyball court flooring system including permanent or portable maple athletic flooring, synthetic floor systems or any quality clip together tile system, including but not limited to Sports Court®, ActiveCourt®, Spider Tile® or Mateflex®.

Any facility regardless of size will value the convenience of these hassle-free, super stable, totally freestanding volleyball standards.



Totally Self-Contained for Easy Transport and Storage



Down Official's End with Optional ABC50 Oversized Logo

Special liftgate delivery charge or extreme manual lifting required if dock/forklift not available.



VB8100LOW Arena™ II Badminton/ Tennis Adapter Kit

Allows Arena II freestanding standards to be used for recreational tennis or badminton • Order nets separately.

Common Applications

VB8100 Arena™ II Portable Freestanding

Large arenas and multi-use facilities or upper floor gyms where elite level volleyball is played but where floor sockets or anchors are difficult, expensive or impossible due to ice rink refrigerant lines, portable flooring system, upper floor location or other constraints will find this system their best option.

VB8102 Shown with Optional ABC50 Oversized Logo

VB8100 Arena™ II Freestanding Portable Volleyball System

No sockets, no problem...Arena II makes life easier • Start-to-finish set up in 15 minutes without tools, floor anchors, guy wires or moving heavy ballasts • Built-in swing-up official's stand • 8" diameter, 2" wide floor-friendly urethane wheels • Safe, attractive and minimally obtrusive padding system available in colors shown on page 102 • Totally padded base size 40" (w) x 47" (l) when in play • Superior net tensioning with lifetime warranty 26:1 backlash free worm gear winch • Pin lock net height adjustability including junior and official men's and women's heights • Transport and storage without removal of padding • Premium Kevlar top rope net • Add lettering to padding at no extra charge (see ABC52) or add logo on side panel padding at an additional cost (ABC50) • Arena II meets all NCAA, National High School Federation and USVBA standards • System includes two bases with posts, built-in official's stand, VB1250K net and storage bag, VB13 antennae, net rope covers, chain net height gauge and complete padding system • **Lifetime limited warranty** on posts and winch. Approx. shipping weight: 3200#; Truck

Complete Systems Include FREE Chain Net Height Gauge, Net Storage Bag and Lettered Post Padding!

"We've used the Bison Centerline Aluminum Volleyball System for years in our program and have loved it. A major facility renovation forced us to move to temporary quarters for a season and we faced the dilemma of using a portable floor in a facility with no floor sleeves. Bison's Arena II Volleyball System worked perfectly for us. It provided us the free standing portability needed without sacrificing net rigidity, ease of set up, player safety or overall quality. And, it looks AWESOME!"

Debbie Brown
Former Head Volleyball Coach
University of Notre Dame



Arena II Model #	Approx. Shipping Weight	Description	Free Pad Lettering
VB8100	3200#, Truck	Complete system including one each of internally ballasted "down official" and "platform" end bases, full padding system, net, antennae, boundary markers, base pad lettering, net rope covers and net height gauge.	Yes
VB8102	3900#, Truck	Complete side-by-side, 2 court Arena II system including one each of internally ballasted "down official" and "platform" end bases, full padding system, VB810 padded center post with winch, center post transport dolly, 2 nets, 2 pair of antennae, 2 sets of boundary markers, base pad lettering, lettered side tapes, net rope covers and net height gauge.	Yes
VB8102DJ	4000#, Truck	Same as VB8102 above except both end bases have built-in officials' platforms.	Yes
VB810	600#, Truck	Arena II center post and winch with transport dolly. Add any number of side-by-side courts to VB8100, VB8102 or VB8102DJ. Order VB810P center post padding, nets, boundary markers and antennae separately.	No





Common Applications

VB8100JR
VB80JR
Arena™ JR
Freestanding Portable

When you want or need a freestanding portable system but also want to use new or your existing posts in additional locations with existing floor sockets.

VB8100JR
Shown with
Optional VB73
Official's Stand
and Free ABC52
Lettering

Arena™ JR Freestanding Portable Volleyball System

The same 3", 3 1/2" or 4" volleyball poles that you use in existing or new gym floor sleeves... Now can be used to create a 100% freestanding portable volleyball system that can be used on any floor, without sockets, loose ballast, floor anchors or guy wires • Arena JR bases are fully padded in your choice of colors shown on page 102 and can easily be transported to and from storage with the transport dolly provided • Just lift the poles from the Arena JR base to use poles inserted into floor sockets in other gyms (see note below) • Order VB8100JR to get complete system including bases, base padding, VB10 Centerline Aluminum 3" posts, post padding, net, antennae, boundary markers, lettered side tapes, pad lettering, net storage bag, net rope covers and net height gauge • If you wish to use your existing 3", 3 1/2" or 4" posts (any brand) and your own net, post padding, etc., order VB80JR for one pair of Arena JR bases with base padding • To create your own Arena JR system by purchasing Bison volleyball components separately, consult a Bison Product Specialist • Order VB73 separately for compatible padded officials platform • Can also be used with VB810 and VB810P Arena II Court Adder to create 2, 3 or more side-by-side volleyball net systems • Lifetime Limited Warranty on post and winch.

NOTE: If you intend to use new posts ordered with Arena JR system exclusively with Arena JR bases and NOT also in typical floor sockets, substitute shortened VB10T posts for full length posts.

VB8100JR Complete Arena™ JR Portable System

Approx. shipping weight: 2750#/each; Truck

VB80JR Arena™ JR Bases and Base Padding Only

Approx. shipping weight: 2500#/pair; Truck



Transport Dolly



Tip for Easy Transport

Complete Systems Include FREE Chain Net Height Gauge, Net Storage Bag and Lettered Post Padding!

Arena JR Model #	Approx. Shipping Weight	Description	Free Pad Lettering
VB8100JR	2750#/pair; Truck	Complete Arena JR System including two end bases, posts (one with winch), net, antennae and boundary markers and base transport dolly.	Yes
VB8102JR	3500#/each; Truck	Complete Side-by-Side Arena JR System including two end bases, one center base, two nets, two pairs of antennae and boundary markers, three posts (two with winches) and transport dolly.	Yes
VB80JR	2500#/pair; Truck	One pair of Arena JR weighted bases with base padding system only. Customer supplies posts, post padding, net and antennae.	No
VB810JR	600#/each; Truck	Arena JR center post base, post and winch. Add any number of side-by-side courts to VB8100JR. Order VB810P center post padding, nets, boundary markers and antennae separately.	No

COURT ADDER FOR ARENA™ II AND ARENA™ JR VOLLEYBALL SYSTEMS



VB810

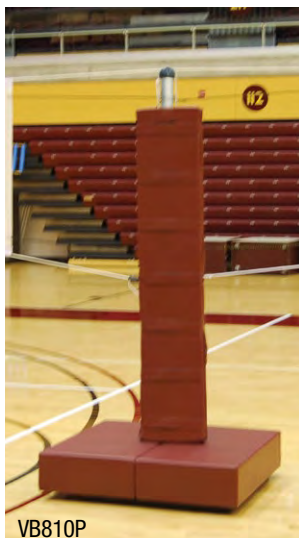

VB810P

VB810 Arena™ Court Adder

Want more side-by-side courts?...Order as many Arena Court Adder center posts as you wish • Each court adder includes base, pole, net tensioning winch and transport dolly • Order net, antennae and VB810P padding system (specify color) separately • Only for use as center post on Arena II and Arena Jr Volleyball Systems • **Lifetime limited warranty** on post and winch • **Order VB810P for complete Arena Court Adder padding** • **Order VB810BASE for base only.** VB810 Approx. shipping weight: 600#/each; Truck. VB810P Approx. shipping weight: 40#/; Truck.



Transport Dolly

WARNING!

Arena II center posts are designed exclusively for use between two Arena II freestanding bases (VB8100). Use as end posts for any net system may result in serious injury caused by tipover.





VB8200/VB8250
QwikCourt™
Portable Volleyball System

NEW!

Easy to set up, easy to transport, easy to store... QwikCourt is designed to be the most affordable, truly portable volleyball system on the market • Extension tube allows the padded ballast box to be positioned approximately 72" away from the padded pole to avoid interference with play • When not in use, the extension and upright are easily folded back without padding removal for transport and storage • Ballast box is fully enclosed and contains 18 32#, 4" x 8" x 16" solid concrete cap blocks (customer supplied) available at any home improvement or lumber center • Entire system including ballast box, floor extension tubes and post have standard black padding meeting NCAA and NJSF rules • Order VB82P to select other padding colors at an additional cost • When in play mode, base sits on floor friendly urethane anti-skid pads • In transport mode, rolls on 6 load spreading 4" diameter floor friendly wheels • Bases accept any manufacturer's 3", 3½" or 4" diameter posts but for guaranteed best compatibility, choose one of Bison's complete competition or recreational system packages from chart below • Complete QwikCourt systems include bases, padding system, posts, net, antennae and net cable covers plus free net storage bag, pad lettering and net height gauge • Order VB73 or VB76 official's platform separately.

Common Applications

VB8200
QwikCourt™

When your facility needs a relatively low cost competition system in areas where floor sockets are impractical or impossible.

Common Applications

VB8250
QwikCourt™

When you want a reliable portable volleyball system for recreational use when floor sockets are not available.



VB8200 Competition
QwikCourt System

This system has all the features listed above and includes Bison's Centerline® aluminum volleyball posts • Post details found on page 47. Approx. shipping weight 750#; Truck.

VB8250 Recreational
QwikCourt System

This system includes all features listed above and includes Bison's Match Point™ posts. Posts details found on page 50. Approx. shipping weight 725#; Truck.

VB82P Optional Colored Padding
System for QwikCourt

Substitute one of 16 colors of padding found on page 102 for the standard black padding on QwikCourt at an additional cost.

Complete Systems Include FREE Chain Net Height Gauge, Net Storage Bag and Lettered Post Padding!

QwikCourt Portable Model Order #	Approx. Shipping Weight	Description	Free Lettering
VB8200	750#/pair	Complete system with two QwikCourt portable bases, 3" Centerline aluminum volleyball posts, worm gear net tensioning winch, Kevlar competition net with storage bag, post and base padding, free post pad lettering, VB13 antennae, net cable covers and net height gauge.	Yes
VB8250	725#/pair	Same complete system as above except includes 3½" Match Point aluminum volleyball posts.	Yes
VB82	625#/pair	Two QwikCourt portable padded bases only. Select all other components separately or provide your own.	No



Centerline™ and Match Point™ Portable Volleyball Systems

When floor sockets are not an option... Bison T-bases to the rescue • Popular standard Centerline Aluminum and Match Point Aluminum Volleyball Systems can be permanently or temporarily mounted into easy-to-transport and store T-bases allowing use of easier-to-install threaded floor anchors • Both systems have all the features of their in-floor socket-style counterparts shown on previous catalog pages including superior net tensioning, easy net height adjustment, durable winch and pole combination and silver gray powder coated finish • Bases have floor friendly transport wheels and easy-to-operate hold down knobs • Each system includes: T-Bases, Centerline or Match Point poles with winch, base and pole safety padding (see page 102 for color options), competition net, net storage bag, net rope covers, four VB25FL floor anchors, antennae and free padding lettering (4 sides) • Consult a Bison Product Specialist if your floor is not a common floating maple design • Order VB76 official's platform separately.

VB1000T Centerline™ Aluminum Portable

Lifetime limited warranty on pole, winch and base. Approx. shipping weight: 245#; Truck

VB6000T Match Point™ Aluminum Portable

10-year limited warranty on pole, winch and base. Approx. shipping weight: 250#; Truck

Complete Systems Include FREE Chain Net Height Gauge, Net Storage Bag and Lettered Post Padding!



VBTBASE T-Base Adapter

Convert virtually any 3", 3½" or 4" volleyball standards into a portable system... Without sacrificing net tensioning • Purchase separately or in complete systems VB1000T or VB6000T above • Eliminates the need to install costly and sometimes impractical or impossible floor sockets for traditional

posts • Order four Bison floor anchors separately (VB25, VB25FL or VB25TF) based on gym flooring system • Features heavy steel construction, floor friendly transport wheels, easy-to-use, built-in floor attachment knobs and durable powder coated finish • If ordered separately, customer will need to order two VB354 sleeve adapters for any 3½" pole system or two VB340 sleeve adapters for any 3" pole system. Approx. shipping weight: 30#/each; Sm. Pkg.



Common Applications

VB1000T Centerline™ Portable Systems

College or high school programs that want all the features of an elite system but find floor socket installation is impossible or impractical. This system only requires installation of four easy-to-install threaded floor anchors.

VB6000T Match Point™ Portable Systems

Budget conscious programs that need portability but won't sacrifice playability. Floor anchors are easier and less costly to install than floor sleeves required on typical in-floor systems.

SVB5050W

Match Point™ Post or Wall Mounted Volleyball System

All the features of Bison's popular Match Point systems on a convenient track system... Track system mounts to customer's supplied posts, walls or any surface strong enough to support desired net tensioning • Net can be infinitely adjusted from 42" (tennis) to 96" (men's

volleyball) net height • System includes VB1250K competition volleyball net, net tensioning winch, net storage bag and net cable covers • Order VB13 boundary antennae separately • Tracks must be mounted between 34" and 40" apart to be compatible with net provided • With customer supplied net rope extension tracks could be mounted wider but net might sag or require additional supports to maintain net height • Five-year limited warranty on track and winch. Approx. shipping weight: 75#; Sm. Pkg. Ships Oversize



VB0050

Universal 2¾" Game Standard System

Excellent value for elementary schools... This system allows infinite height adjustment between 42" tennis net height and 96" competition volleyball height • Crankless net tightening • Heavy wall steel standards with grey powder coated finish • Standards come with adapters to allow installation into 3" or 3½" existing floor sockets in addition to the VB24

floor sockets provided • SVB08 net is standard • If you are purchasing this system only as an official sized badminton court request substitute BM10N badminton net and install sockets 21" apart instead of the 36" - 37" standard width for volleyball courts • If this system will be installed on a floating maple floor add VB23-CV floating floor plates (not included) • Can be used with VB51P post padding • One-year limited warranty. Approx. shipping weight: 140#; Truck



SVB1000 Centerline® Elite Sand Volleyball System

You supply the sand...Bison will supply the rest • You won't need to sacrifice ease of setup, safety or net tensioning with Bison's Centerline Elite Sand Volleyball Systems • Bison's exclusive TwistLock™ removable stainless steel sand sockets not only allow easy removal of posts when not in use but also eliminate the problem of sand or water filling the socket • Centerline Sand Volleyball posts have all the great features that have made Centerline Elite a standard in the industry plus special features for outdoor and indoor sand court use including stainless steel hardware and other weather and sand proofing features • As an added bonus, the same 3" Centerline posts can be used indoors on your hardwood floor court and outdoors without modifications for maximum equipment utilization • Complete system includes special Centerline 3" sand aluminum posts, lifetime warranty net tensioning winch, competition TwistLock stainless steel sockets, player safety padding (see page 102 for color options), competition Kevlar top rope net (substitute SVB1250K for VB1250K for installation at official 8.5M 2 on 2 sand volleyball play) antennae, net and antennae storage bag, net rope cover and net height indicator • You'll also get FREE post pad lettering on all complete system orders • Order SVB73 Sand Volleyball Officials Stand and boundary kit separately • Systems meet all applicable high school and college rules. Approx. shipping weight: 300#, Truck

SVB1250K Competition Sand Volleyball Net
Our VB1250K top quality Kevlar top rope net with heavy white side tapes (see page 60) except shortened to 8.5 meters for official NCAA 2-on-2 sand volleyball • One-year limited warranty. Approx. shipping weight: 12#, Sm. Pkg.

SVB1002 Centerline Side-by-Side Double Court Sand Volleyball Systems
Need two courts but want to save money?...Bison side-by-side courts are the answer • Three posts, two net tensioning winches, three TwistLock sand ground sockets, two nets, two antennae and post padding are all included in this complete package • As an added bonus, free pad lettering on the outside end posts, free net and antennae storage bag and free net chain net height indicator makes this a truly complete package. Approx. shipping weight: 425#, Truck

SVB100 Centerline Sand Volleyball Court Adder
Need even more side-by-side courts?...Purchase one court adder plus additional VB1250K nets, VB510P post padding, VB13 antennae/boundary markers and SVB23 sand ground sockets to string as many courts together as desired • Each SVB100 includes one Centerline Elite Sand Volleyball post and lifetime warranty net tensioning winch. Approx. shipping weight: 50#/each; Truck

SVB23 and SVB27 TwistLock™ Sand Volleyball Sockets
Now you see it...Now you don't • Unique twist lock design allows the socket to be installed or removed from a permanent concrete base foundation in a matter of seconds • No more water or sand filled sockets or sockets that protrude above the sand • These stainless steel sockets will not rust even if left installed year round • The unique concrete foundation with imbedded base plate design has a leveling feature to allow precise post leveling and eliminate installation errors • TwistLock sockets come standard with Centerline Elite single and side-by-side systems but can be ordered separately to use with any 3" Bison or other indoor competition volleyball systems for maximum utilization of existing equipment • Order SVB27 for TwistLock 4" Sand Volleyball Sockets available for Bison VB9000 UltraLite or other manufacturers 4" systems • Order VB354 to allow installation of 3½" volleyball posts in SVB27 4" sockets. Approx. shipping weight: 50#/each; Sm. Pkg.

SVB26 Boundary Kit
Bright orange ¼" rope with excellent outdoor durability...Includes storage reel and corner stakes • Can be used on grass or sand. Shipping Weight: 4#, Small Package

SVB28 Premium Sand Boundary Kit
Kit comes complete with ½" yellow rope spliced into a continuous loop to mark the outer boundary of an official sand volleyball court...Includes galvanized ground anchors that screw below the playing surface for maximum player safety • Two-year limited warranty. Approx. shipping weight: 26#, Sm. Pkg.

SVB73 Sand Volleyball Official's Platform with Padding
Perfect for sand courts...Same great features as our indoor Clamp-On Officials Platform but with special sand skids instead of wheels to avoid sinking into the sand • Includes gray padding system conforming to all NCAA, National High School Federation and USVBA rules • Substitute padding in black, maroon, navy, royal or scarlet at an additional cost • Five-year limited warranty on stand. Approx. shipping weight: 90#/each; Truck

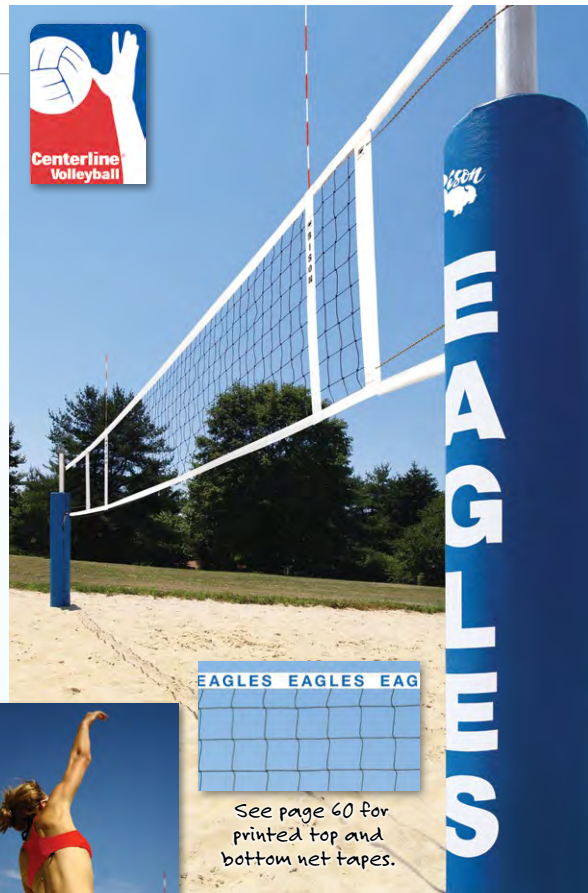



Strap Style
Worm Gear Winch

SVB5000 Shown with Optional ABC52 Lettering

SVB5000 Match Point™ Competition Outdoor Volleyball System

Sand volleyball can now be played at the same level as on the hardwood court... Rugged system designed for California-style power volleyball • 3½" posts are galvanized and powder coated for maximum rust resistance • Net is infinitely adjustable to insure exact net height for competition or recreational volleyball • Tightens with the same mechanism found on our Match Point competition systems • **Includes post padding, net and antennae** • Optional padding lettering or logo available for team or sponsor recognition (ABC51, ABC52 and ABC53) • Install permanently in concrete or using optional SVB210 ground sleeves • Five-year limited warranty. Approx. shipping weight: 260#; Truck

Model SVB5000 Components		Warranty
SVB50	Competition Outdoor Volleyball Standards	Five-Year Limited
VB1250K	Competition Net	One-Year Limited
VB13	Sideline Antennae	90-Day Limited
VB51P	Post Padding - 17 Colors	90-Day Limited Outdoor

SVB5050 Outdoor Volleyball System

Same system as SVB5000 except without antennae and padding... Five-year limited warranty. Approx. shipping weight: 225#; Truck

SVB500 Court Adder for SVB5000 or SVB5050

Designed for adding additional courts with a single post... Includes post, net tensioning and adjustment mechanism • Other components sold separately • One SVB500 adds one side-by-side court, order multiple SVB500s to add more courts • Five-year limited warranty. Approx. shipping weight: 115#; Truck

SVB210 Ground Sleeve (not shown)

For removable installation of SVB5000, SVB5050 or SVB500... This steel sleeve, buried in concrete, allows for easy removal of posts when not in use • When installed according to instructions, the top of the sleeve is approximately 6" below the top of the sand, so sand can be used for other activities • Durable molded plastic cap keeps sand out • Each system requires two sleeves. Approx. shipping weight: 35#/each; Sm. Pkg.



SVB2000A

SVB2000A Aluminum Recreational Volleyball System

The perfect volleyball system for playing in the sand or grass whenever the goal is fun...

Recreational leagues, beach resorts, campgrounds, playgrounds, parks, school yards, any place where a group gathers to play volleyball • 3½" diameter aluminum extruded posts permanently install in a 30" deep x 8" diameter concrete footing or can be installed using VB21 ground sleeve (optional) to allow easy removal of the poles when not in use • Rigid, lightweight aluminum is 100% rust-proof • Net is infinitely adjustable from men's competition volleyball height, 7' 11½", to as low as 42" tennis height • Poles are capped to keep out moisture • Crankless net tightening • Powder coated finish • Includes net with fluorescent top tape and all necessary hardware • Two-year limited warranty on standards.

Approx. shipping weight: 110#; Truck



SVB08 Recreational Volleyball Net

Official size 32' x 36" nylon net with

fluorescent top tape for maximum visibility... Nylon top rope • Black webbing • Fits SVB2000A and VB0050 Bison systems and most net games • Weather-resistant • Net color subject to change • 90-day limited warranty. Approx. shipping weight: 3#; Sm. Pkg.



SVB400

SVB400 Portable Volleyball/ Badminton Set

Enjoy net game fun including volleyball or badminton anywhere you go... Family picnics, class reunions, summer camp or school outings • You'll be ready to play quickly with snap together poles • System includes poles, net, guy ropes and zippered carrying case. Approx. shipping weight 3#; Sm. Pkg.



VB21 3½" Round Ground Sleeve

These aluminum ground sleeves allow removal of your SVB2000A aluminum volleyball system... Sleeves mount permanently in a 30" deep x 10" diameter hole filled with concrete • Cap keeps out rain, snow and dirt • SVB2000A requires two sleeves, each sold individually. Approx. shipping weight: 9#; Sm. Pkg.



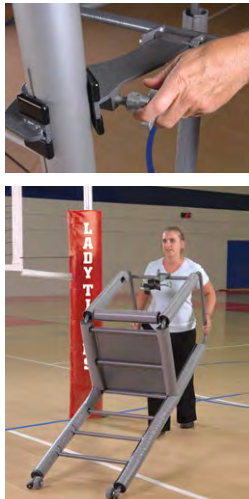

VB73 Clamp-On Official's Platform with Padding

Popular design is compatible with most volleyball systems that use floor sockets regardless of manufacturer...3", 3½" or 4" standards • Unique and stable clamp grasps post at approximately 74" above the floor to eliminate interference with required post padding • Widened platform and taller side rails increase official's comfort and safety • Floor-friendly wheels allow easy transport to and from storage • When in use, sits on non-slip rubber floor pads • Heavy-duty 1" diameter tubular construction is covered with 1" thick matching gray vinyl covered foam padding to meet all NCAA, National High School Federation and USVBA rules

- Substitute padding in black, maroon, navy, royal or scarlet at an additional cost
- Not recommended for use with VB6000, VB2000T, VB6000T, or systems utilizing VBTBASE adapters
- Order SVB73 for use on sand volleyball courts
- Five-year limited warranty. Approx. shipping weight: 75#/each; Truck

VB73A Adjustable Height Clamp-On Officials Platform with Padding

Same design as VB73 above except with 6 pull pin leg length adjustments in 1" increments to allow platform height to best match the net and Up Official height for best line of sight.



V VB76 Freestanding Folding Volleyball Official's Platform with Padding

The perfect balance of stability and storability...Meets all NCAA, National High School Federation and USVBA rules • Easy pull-pin folding design • Powder coated heavy gauge steel construction • Floor-friendly wheels and floor pads • Includes color coordinated gray padding

- Substitute in black, maroon, navy, royal or scarlet at an additional cost
- One-year limited warranty. Approx. shipping weight: 120#/each; Truck

VB73, VB73A, SVB73 and VB76 Padding Colors



VB51P Post Padding for All Stationary Standards

Protects players from contact injury...

Meets NCAA, USVBA and National High School Federation rules • Fits all Bison post style standards • Also fits most other manufacturers' volleyball posts • 1" thick high density foam with Velcro closure • Protects to 6' height

- Stocked in colors shown on page 102
- Order padding for court adders
- Five-year limited indoor warranty, 90 day outdoor. Approx. shipping weight: 20#/pair; Sm. Pkg.

VB510P Center Post Padding

Same high quality 1" thick foam padding but designed to cover center standards on Bison side-by-side double volleyball systems... Velcro attachment

- Lettering not available on VB510P
- Five-year limited warranty. Approx. shipping weight: 10#/; Sm. Pkg.

VB51PL Universal Volleyball Post Padding with 4-Sided Lettering

Spruce up your in-floor equipment... regardless of post diameter or original post brand or model number • Same padding specifications as VB51P above but with the addition of 4 sided, one-color lettering to highlight your school spirit • See page 102 for lettering color options.



ABC52 Letter Styles



ABC53 Second Color Letter Outline



ABC54 Full Color Vinyl Decal Logo

NEW!

Add custom logos to any Bison vinyl padding or flat powder coated surface... decal will be installed at factory if ordered at same time as padding • Field install to existing Bison or other manufactured volleyball, basketball, wall or football goal post padding • Digitally printed on high-tack 3M 5 mil adhesive vinyl, die-cut and ready to apply • Maximum size 12" x 12" • Contact Bison Art Department for design assistance or provide image in vector format. Approx. shipping weight: 1# each, Sm. Pkg.

VB51PW Sport Pride Volleyball Post Padding Wraps

Add full color graphics, change logo or change padding color without replacing existing padding...

or order with new system to enhance the look of your new Bison volleyball system • Fits only Bison VB51P padding • Velcro attachment

- Bison graphics department will work with you to design a custom full color professional image that can include logos, photos, lettering or any graphics desired
- Sold in pairs
- Clear lamination protects printed surface for long life. Approx. shipping weight: 20#/pair; Sm. Pkg.



NEW!

While designed to fit Bison volleyball standards, all Bison padding will also cover most other manufacturers' in-floor volleyball standards.





VB1253W

Net Storage Winders

Tired of wadded up, dirty, and tangled volleyball nets?... Here is your answer • Roll and store nets when not in use • 24" dome base has non marking wheels to roll easily to and from storage • Nets hang neatly and dependably on rotating top spider • Choose **VB1251W** for single net, **VB1252W** for 2 net and **VB1253W** for 3 net capacity.

Approx. shipping weight: 70#; Sm. Pkg.

VB96 Six Post Deluxe Volleyball Cart

Easy loading, easy transport, easy storage...

For all your volleyball program's needs • Safely and securely holds 6 padded posts or up to 12 without padding • Versatile fabric cradle holds nets, antennae, cable covers, balls or padding • Top storage rack can hold officials stand or padding allowing everything you need to be wheeled through a 36" wide door • Sturdy powder coated steel structure with 4" floor friendly, swivel casters for easy movement • Five-year limited warranty.

Approx. shipping weight: 90#; Sm. Pkg.



VB95 Multi-Court Volleyball Storage System

Store it all, up to four courts on a single compact cart... Eight posts, four nets, eight post pads, four pair of antennae and up to 12 volleyballs can all be neatly stored and easily transported from storage room to court by even your smallest player • 1" square, heavy wall tubular frame has a durable silver gray powder coated finish • Spreader rods are 3/4" diameter steel with a chrome plated finish • Four 150# capacity floor-friendly casters will support even the heaviest steel volleyball standards • Loaded dimensions depend on pole length and padding stack height • Unloaded cart dimensions are 28" (w) x 60" (l) x 58" (h) • Design protects nets from dirt, poles from damage, padding from tears and antennae from breakage • Customize your cart with optional ABC92 custom vinyl lettering • Five-year limited warranty.

Approx. shipping weight: 91#; Sm. Pkg.



VB94 Volleyball Four Post Transport Cart

Heavy-duty design allows compact and easy storage and transport of up to two complete volleyball systems... Compatible with any brand of 3", 3 1/2" or 4" outside diameter posts • Non-marking, 4" swivel casters • Bonus storage for net and padding • Durable, white powder coated finish • Reduces damage to posts and floor • Total width when loaded is 30", allowing transport through most doors • Eliminates multiple trips from storage to set up equipment • One-year limited warranty.

Approx. shipping weight: 88#; Sm. Pkg. Ships Oversize



VB92 Volleyball Standard Wall Storage Rack

Keep any 3" to 4" diameter volleyball standards safely stored without damage... Order one VB92 for each pair of standards • Mount to any wall with customer supplied mounting hardware.

Approx. shipping weight: 7#; Sm. Pkg.



VB9130, VB9135, VB9140 Volleyball Pole Caddies

Make transport of your volleyball poles easy and safe... fits any manufacturer's poles • 3" floor friendly wheels and 8" tall receiver socket • Choose **VB9130** for 3" poles, **VB9135** for 3 1/2" poles or **VB9140** for 4" poles.

Approx. shipping weight 5#/each, Sm. Pkg.





Notice! Volleyball nets are not returnable once opened unless defective.

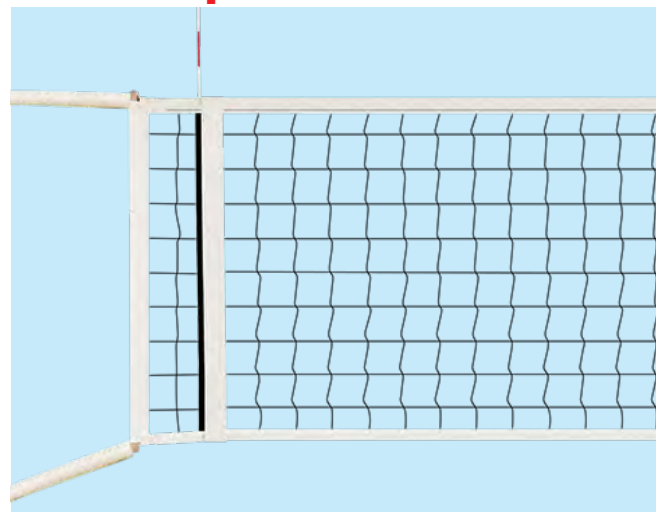

VB1250K Kevlar Competition Volleyball Net

This net is designed specifically to install easily and bowstring tight on our Centerline, CarbonMax, Lady CarbonMax and Match Point systems...Totally encased stretcher bar • ¼" no-stretch Kevlar top rope and ⅜" tenex bottom rope • Knotless woven webbing for tighter square net tensioning • White top, bottom and side tapes • Meets all appropriate association rules • 32' x 1 meter official size • Four easy operating rope ratchet side tape tensioners • Rope ratchet bottom rope tensioner • Top and bottom ropes extra long to allow use with floor sockets from 35'-45' apart • May require field shortening of top rope • **Includes zippered net storage bag and top and bottom rope cable covers** • Two-year limited warranty. Approx. shipping weight: 15#. Sm. Pkg.

VB1298 QwikSet™ Competition Volleyball Net

Designed specifically for fast and easy set up on Bison UltraLite systems... No need for extra side tape tensioners as top and bottom rope tensioning results in superior net tension • Knotless woven webbing and bright white top, bottom and side tapes • Rope ratchet bottom rope tensioner • **Net storage bag and top and bottom rope cable covers included** • 32' x 1 meter official size • Net compatible with posts positioned between 34½' and 38¼' apart • Consult a Bison Product Specialist if posts are not within this range • Two-year limited warranty. Approx. shipping weight 15#. Sm. Pkg.

FREE Zippered Net Storage Bag
with purchase of a VB1250K or VB1298 net



V VB1250KU Universal Competition Kevlar Volleyball Net

Similar design features as our VB1250K Kevlar Competition Net...makes a great spare net for practice or for competition and is compatible with not only Bison systems but also Sports Imports (Senoh), Spalding and most other manufacturer's pole systems • Call for complete list of compatible volleyball systems • Features heavy white side, top and bottom tapes • 4" square knotless mesh, Kevlar top rope and polypropylene bottom rope and set of 4 ratchet style side tape tensioners • One-year limited warranty. Approx. shipping weight: 13#. Sm. Pkg.

SVB1250K Official Kevlar Sand Volleyball Net

Same high quality competition net as VB1250K above except...official 8.5 m (28') long • One-year outdoor warranty. Approx. shipping weight: 12#. Sm. Pkg.

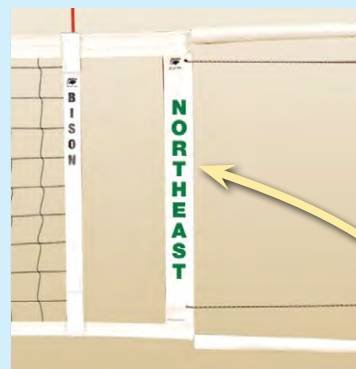

VB1250ST School Spirit™ Side Tape Covers

Show your school pride...See your school name on the sports page or TV highlights • Velcro attached side tapes have a white background • Select from letter styles below • See page 102 for color options (one color only) • 10 letters maximum, 24" x 2" imprint area • Printed on both sides • Sold in pairs (per net) • Fits most manufacturers' competition nets • One-year limited warranty. Approx. shipping weight: 5#/pair; Sm. Pkg.

Letter Styles

A ABC B ABC c ABC D ABC



VB1250SP Sport Pride™ Volleyball Net Band

See your program's name or logo on the sports page...Customize this add-on white net tape • Velcro's onto any manufacturers' net in less than five minutes • Full-color logo or lettering on a white background • Permanent ink and lamination for lasting school spirit • Remove and reinstall as you replace nets • Allow 4-6 weeks • One-year limited warranty. Approx. shipping weight 3#/each; Sm. Pkg.





VB123 NetSet™ Volleyball Net Tensioning Gauge

Never guess at proper net top rope tension again... Find the best tension setting for your system and count on an exact repeat every time • Gauge installs between the winch and the top rope on all Bison and most manufacturers' competition systems • Easy-to-read 1-2-3 tension indicators • Mark your desired setting with a permanent marker so no matter who sets up the system, it will be the same as the last time • Anodized aluminum body, chromium steel spring, red line indicator, plated steel internal plunger and heavy-duty spring clip connectors • Two-year limited warranty. Approx. shipping weight: 2#; Sm. Pkg.



VB98HG Chain Net Height Gauge

Eliminate the need for tape measures or bulky poles with this easy-to-use chain net gauge... Multiple indicators for all common net heights • Complete with small zippered storage bag, instructions and spring clip to store gauge behind padding attached to the pole or net rope. Approx. shipping weight: 1#; Sm. Pkg.

VB99HG Premium Telescoping Net Height Gauge

Perfect net height is now achievable with this easy-to-use tool... Measure any common competition net height • Aluminum telescoping pole folds to only 39" length for easy transport in nylon storage bag. Approx. shipping weight 2#; Sm. Pkg.

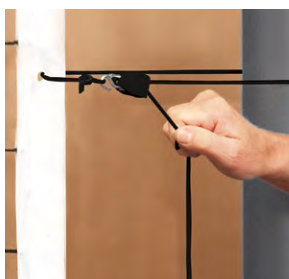
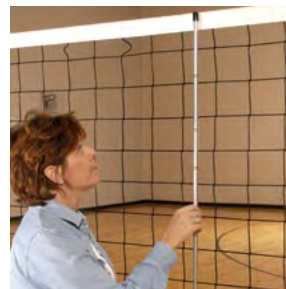

VB1200RR Rope Ratchet Net Tensioning Kit

Purchase this set of four net tension ropes to replace or supplement current volleyball side tape tensioning devices... Easy ratchet design pulls tight, then releases with the push of a button • Quick, easy and safe • Tensioners are standard on Centerline, CarbonMax, Lady CarbonMax and Match Point systems but are available for lost or worn tensioners and for any system when horizontal net tensioning is needed • Set of four. Approx. shipping weight: 1#; Sm. Pkg.



VBVELCRO Replacement Bottom Net Rope Collars

Use to replace lost collars that came with all Bison volleyball systems. Sold in pairs. Approx. shipping weight: 1#/pr.; Sm. Pkg.



VB13 SideLine™ Antennae

Clearly mark the court sidelines with this combination antennae and bright white boundary tape... Attach easily with hook and loop fasteners • Official size two-piece antenna slips neatly into pocket • Fit either 36" or 1 meter nets • No fasteners to lose • Meets all NCAA, National High School Federation and USVBA rules • 90-day limited warranty. Approx. shipping weight: 4#/pair; Sm. Pkg.

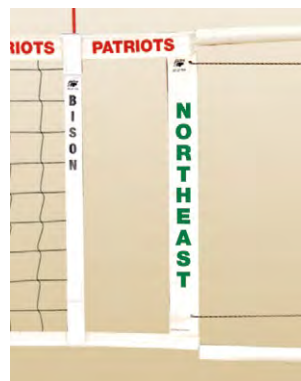

VB35P Cable Covers

Protects players on any manufacturers' system... Each 24" long • Can be shortened in 2" increments to 16" • Set of four. Approx. shipping weight: 1#; Sm. Pkg.

VB231K Hinged Brass Floor Plate Cover Installation Kit

Install Bison VB23, VB26, VB27, VB23-CV, BM23, VB23LK-CV or VB23CH-CV Floating Floor Socket Covers with professional results... Two-piece router template kit can be used over and over for perfectly sized pockets in floating wood floors • Router and router bits not included. Approx. shipping weight: 5#/kit; Sm. Pkg.



Thru Hole Template



Step Bore Template





VB01XL **AcuSet™** Volleyball Trainer

Improve setting and passing skills...Great for training at all ages and skill levels • New design for superior stability, durability and transportability • Factory weighted dome base with non marking wheels tips backward for repositioning and transport • Set 30" diameter target ring at any height from 7' to 12' in 2" increments or any angle with easy locating pull pins • Use with VB185 or BA175 below for ball retrieval. Approx. shipping weight: 150#, Truck



VB185 **Easy Reach™** Volleyball Cart

Durable lightweight cart holds up to 30 balls...Lining constructed of black 600 Denier Cordura • Quick-fold design provides simple compact storage • Equipped with swivel casters for smooth rolling from locker room to gym • Chrome plated tubular frame • Includes storage bag for transport and off-season use • Perfect for use with AcuSet Volleyball Trainer • One-year limited warranty. Approx. shipping weight: 15#, Sm. Pkg.



BA175 **Ball Security Locker**

Secure your investment in inflatables...Sturdy blue powder coated wire and tubular locker • Hinged, lockable top (lock not included) • Overall dimensions 24" (w) x 36" (l) x 35" (h) • Easy to roll with convenient handle and heavy-duty swivel casters • Holds approximately 25 to 30 basketballs, volleyballs, soccer or miscellaneous game balls and equipment • One-year limited warranty. Approx. shipping weight: 50#, Sm. Pkg. Ships Oversize



Floating Floor Sockets with Brass Floor Plate

Premium quality, cast brass floor plates are machined for a high quality fit and finish...Hinged for easy use • Subfloor excavation and hardwood floor routing required for installation in existing floors • Use with Bison equipment or any 3", 3½" or 4" standards • 8" outside and 6" opening on cover plate • Select size below • Sockets allow floating floor to expand and contract with changes in humidity • Requires two per system.

VB23

CAUTION! Floor sockets are difficult and often impossible to install on floors with basements or other hollow cavities below, consult an experienced installer for assistance.

Model #	Size	Used with Bison Posts/Systems	Description	Shipping
VB23	3"	Centerline, CarbonMax, Lady CarbonMax	3" diameter x 10" deep	9#/each; Sm. Pkg.
VB26	3½"	Match Point	3½" diameter x 10" deep	9#/each; Sm. Pkg.
VB27	4"	UltraLite	4" diameter x 13" deep	8#/each; Sm. Pkg.



Standard Floor Sockets

The same special extrusions as Bison floating floor sockets but with a machined aluminum ring and cover assembly...Use on all nonfloating floor systems, including concrete, tile or synthetic • Aluminum cap • Requires excavation of existing floors • Requires two per system • Select size below.

BM21 Badminton Floor Sockets

Compact hinged brass cover...hides 12" deep socket designed for 1½" square badminton or other game posts • 4½" outside and 3" opening diameter. Approx. shipping weight: 5# each; Sm. Pkg.

VB235

BM21

CAUTION! Floor sockets are difficult and often impossible to install on floors with basements or other hollow cavities below, consult an experienced installer for assistance.

Model #	Size	Used with Bison Posts/Systems	Description	Shipping
VB24	2¾"	Universal Game Standards VB0050	2¾" diameter x 12½" deep	5#/each; Sm. Pkg.
VB235	3"	Centerline, CarbonMax, Lady CarbonMax	3" diameter x 9" deep	9#/each; Sm. Pkg.
VB21	3½"	Match Point	3½" diameter x 9" deep	9#/each; Sm. Pkg.
VB22	4"	UltraLite	4" diameter x 13" deep	3#/each; Sm. Pkg.
BM21	1½" sq.	BM10 Badminton	1½" sq. x 12" deep	9#/each; Sm. Pkg.

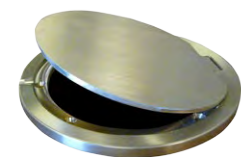

VB23-CV Hinged Brass Plate Floor Cover

Cover plate only for replacement use...8" outside diameter and 6" diameter openings. Approx. shipping weight: 5# each; Sm. Pkg.



VB23LK-CV Lockable Hinged Brass Floor Plate Cover

Same hinged brass design but includes a keyless locking device to avoid unwanted access to socket...Substitute VB23LK-CV for standard brass floor plate • Floor plate only, no socket included • 8" outside diameter and 6" diameter opening. Approx. shipping weight: 5# each; Sm. Pkg.



VB23CH-CV Chrome Plated Swivel Cover

Cover plate only...8" outside diameter and 4½" diameter opening • Steel with polished chrome finish • Includes lifting key. Approx. shipping weight: 5# each; Sm. Pkg.

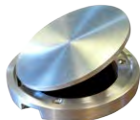

BM30-CV Small Hinged Brass Plate Cover

Cover plate only for badminton...or other needed floor cutouts • 4½" outside diameter and 3" diameter opening. Approx. shipping weight: 3# each; Sm. Pkg.

FREE! Upon Request

(with complete system orders)

Volleyball Sleeve Adapters

Install 3" diameter or 3½" diameter volleyball systems in any manufacturer's existing 4" or 3½" floor sockets...Order one per each existing socket. Approx. shipping weight: 5-7#/each; Sm. Pkg.

VB354 To Install 3½" Posts in 4" Floor Sockets

VB340 To Install 3" Posts in 4" Floor Sockets

VB335 To Install 3" Posts in 3½" Floor Sockets



VBDSS Socket Depth Adapter (not shown)

If your existing sockets are extra deep...You may need depth adapters to allow proper installation of your volleyball poles • Bison will provide, free of charge, custom depth adapters with the purchase of any Bison volleyball system • Provide diameter and depth of existing sockets and model of Bison system. Approx. shipping weight: 1#; Sm. Pkg.



VB25 Standard Drill-In Floor Anchor

Allows anchoring of portable volleyball or basketball systems to existing concrete, synthetic or tile floors without major concrete excavation...Provides ½" threaded hole with spring loaded plug • Requires core drilling and grouting. Approx. shipping weight: 2#/each; Sm. Pkg.



VB25FL Drill-In Anchor for Common Floating Floors

Same as VB25 except with flange to add additional anchor support when installed on floating maple floor systems... Includes all necessary hardware • Requires concrete core drilling, routing of wood floor and grouting of anchor into concrete • Provides ½" threaded hole with spring loaded plug. Approx. shipping weight: 3#/each; Sm. Pkg.



VB25TF Thin Slab Drill-In Floor Anchor

Wide range of thin slab applications...Use on athletic floors that have playing surface installed directly over a concrete surface such as tile or synthetic and where the concrete is too thin to allow the use of VB25 or VB25FL • Same ½" threaded insert hole with spring loaded plug • No hardware is provided as this anchor is used in a wide range of applications • Consult a Bison Product Specialist. Approx. shipping weight: 2#/each; Sm. Pkg.

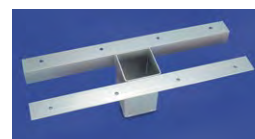

VB230 Second Story Volleyball Socket Form

Just what you need to install volleyball sockets in floors with lower level or crawl space directly below volleyball court...

Prefabricated form can be used as is or field modified

• Use in conjunction with any Bison floor socket • Heavy welded steel with powder coated finish • Requires experienced installer for proper use. Approx. shipping weight: 45#; Sm. Pkg.

Floating Floor Sockets with Chrome Plated Swivel Covers

Purchase separately or substitute for brass hinged floor plates standard in most Bison systems...Available with 3", 3½" or 4" floor sockets or order cover without socket • 8" outside diameter and 4½" diameter opening. See chart below for ordering details.

Model #	Size	Used with Bison Posts/Systems	Description	Shipping
VB23CH	3"	Centerline, CarbonMax, Lady CarbonMax	3" diameter x 10" deep	8#/each; Sm. Pkg.
VB26CH	3½"	Match Point	3½" diameter x 10" deep	8#/each; Sm. Pkg.
VB27CH	4"	UltraLite	4" diameter x 13" deep	8#/each; Sm. Pkg.



See page 103 to send your photo/video to Bison



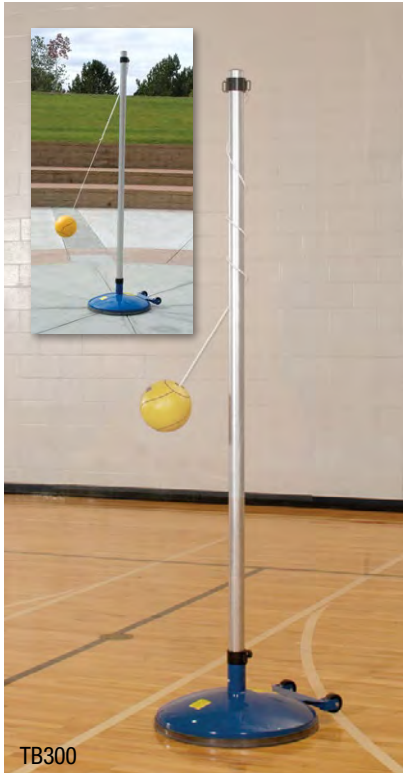

TB300

TB300 Indoor/Outdoor Portable Tetherball Set

Play anywhere... 1 $\frac{3}{4}$ " diameter, 10' galvanized steel pole mounted to 24" diameter steel base with 130# of built in ballast for stability • Easy roll wheels • Includes ball, rope and top ring • Non-marking rubber ring on bottom of base • Quick set up with no hole to dig or loose weight bags to carry • One-year limited warranty on pole and base. Approx. shipping weight 175#; Truck

TB100 In-Ground Tetherball Set

Long-lasting outdoor durability... Includes 1 $\frac{7}{8}$ " diameter galvanized steel pole, PVC ground sleeve for easy pole removal when not in use, rope attachment ring and tetherball with rope • One-year limited warranty on pole. Approx. shipping weight 22#; Truck

TB100P Tetherball Pole and Ground Sleeve Only

Order ball separately. Approx. shipping weight: 20#; Truck

TB50-B Replacement Tetherball Quality ball with rope and attachment clip.

Approx. shipping weight: 2#; Sm. Pkg.



TB100

allied
TUBE & CONDUIT®
A PART OF **atkore**

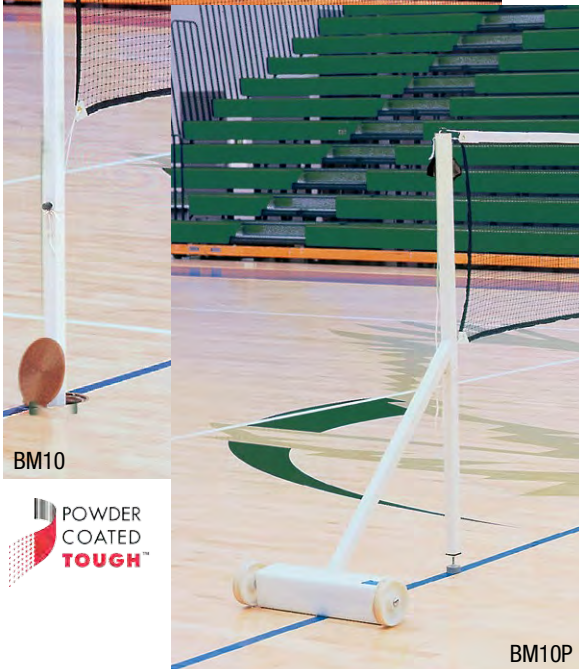
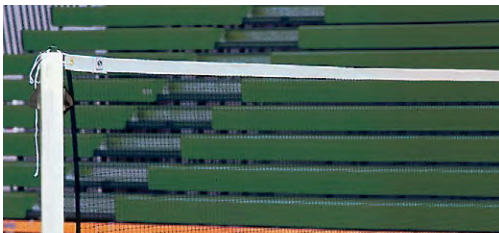

BM10

BM10P

POWDER COATED TOUGH™

BM10 Competition Badminton System

For official competition or physical education class... Suits every level of play • 1 $\frac{11}{16}$ " square aluminum standards designed to set up and tear down quickly • System includes official net • Order BM21 sockets and brass floor plates separately • Consult with a Bison product specialist for replacement systems for existing sockets • Two-year limited warranty. Approx. shipping weight: 25#; Sm. Pkg.

BM10P Portable Badminton System

Competition play without sockets or floor anchors... Portable yet sturdy • Each end support is designed with a 1 $\frac{11}{16}$ " square post with built-in ballast outrigger and floor friendly transport wheels • Quick and easy set up, tear down and storage • Two-year limited warranty. Approx. shipping weight: 100#; Truck

BM10N Official Badminton Net

Nylon competition badminton net... Official 20' x 2 $\frac{1}{2}$ ' size • Fits any standard badminton system • 90-day warranty. Approx. shipping weight: 4#; Sm. Pkg.

BM21 Standard Floor Socket for 1 $\frac{11}{16}$ " Square Badminton Posts (not shown)

Compact hinged brass cover... hides 12" deep socket designed for 1 $\frac{1}{2}$ " square badminton or other game posts • 4 $\frac{1}{2}$ " outside and 3" opening diameter. Approx. shipping weight: 5# each; Sm. Pkg.



TN10 shown with optional TN23 sockets

TN10CS Center Court Hold Down Straps
For net replacement on any tennis court...Replacement center strap assembly. Approx. shipping weight: 2#; Sm. Pkg.

TN23 Indoor Tennis Floor Socket/Floor Plate
Remove tennis posts with ease...10" deep socket installs into court surface • Hinged brass floor plate covers socket when posts are removed. Approx. shipping weight: 9#each; Sm. Pkg.

TN235 Outdoor Tennis Ground Socket/Ground Plate
Same as above but made for the outdoor court...100% removable aluminum cover. Approx. shipping weight: 9#each; Sm. Pkg.

TN10 Competition Tennis System

Indoors or outdoors...Competition system for any level • 41' net with 46' coated top cable (TN10N) • 3" round, high tensile aluminum posts with durable powder coated finish • Chrome plated internal winch to tension top cable • Removable handle • System includes posts, indoor/outdoor official net and center court net hold down strap • Order optional sockets separately for easy post removal • Consult with a Bison product specialist for replacement systems for existing sockets • Two-year limited warranty. Approx. shipping weight: 40#; Sm. Pkg.



TN10

TN05 Recreational Tennis System

These 3" diameter 3/16" wall steel posts have 1/4" diameter welded steel net side lacing loops and dome net cable guides for durability...Tennis green powder coated finish • Includes backlash free net cable tensioner, TN10N net and TN10CS center court hold down strap • Use as permanent posts or order optional **TN23** or **TN235** sockets for easy removal • One-year limited warranty. Approx. shipping weight: 90#; Sm. Pkg.

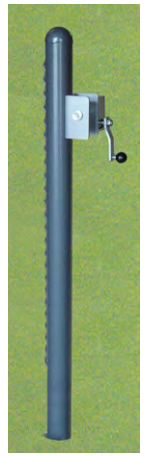

TN05

TN10N Premium Tennis Net

For net replacement on any tennis court...Use indoor or outdoors • Includes center court net hold down straps and all required net attachment ropes • 41' net with 46' coated top cable (TN10N) • One-year limited warranty. Approx. shipping weight: 16#; Sm. Pkg.

TN500BNP 4' Tennis Player Bench

These 4' portable benches will seat 2 or 3 in style... Forest green 2" x 10" x .08" aluminum seats and backs • All player bench structures are constructed of 2" square aluminum tubing with a black powder coated finish and include rubber feet to allow indoor use without damaging floors and to keep legs from deteriorating in wet grass • Five-year limited warranty. Approx. shipping weight: 60#each; Sm. Pkg.



PICKLEBALL SYSTEMS

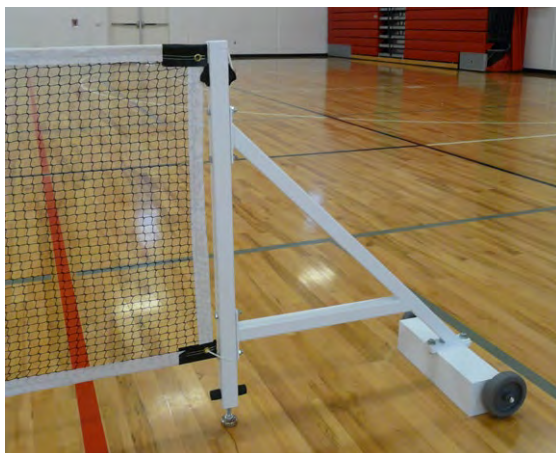

PK10 Official Pickleball System

For the pickleball purist...standards designed specifically for the fast growing game of pickleball • Meets all IFP and USAPA rules • Can be installed indoors or outdoors specifically for pickleball using BM21 Sockets (order separately) or installed in existing 3", 3 1/2" or 4" diameter volleyball sockets using adapters shown below • System includes 1 1/16" square, white powder coated aluminum standards, crankless net tensioning system, weighted center net hold down and competition net • Two-year limited warranty. Approx. shipping weight 25#; Sm. Pkg.

PK10P Official Portable Pickleball System

Don't be fooled by lightweight toys...this is the real deal • This heavy-duty, portable base rolls easily into playing position and stays put when the net is tensioned unlike molded plastic weighted bases • System includes outrigger ballast with floor friendly wheels, 1 1/16" powder coated aluminum uprights, crankless net tensioning system, weighted center net hold down and competition net • Two-year limited warranty. Approx. shipping weight 100#; Truck.

PK10N Official Pickleball Net

Official 20' x 2 1/2" size with white top tape • 90 day warranty. Approx. shipping weight 4#; Sm. Pkg.

BM21 Pickleball Floor Sockets

For new installation in all types of playing surfaces • Rust free aluminum sockets with hinged brass floorplate • Requires 2 per system. Approx. shipping weight 9# each; Sm. Pkg.

Post Adapters

Use Bison 1 1/16" pickleball or badminton posts in existing volleyball sockets • Specify **BM300A** for 3" sockets, **BM350A** for 3 1/2" sockets or **BM400A** for 4" existing sockets • Aluminum adapters install without tools for quick setup • Sold in pairs. Approx. shipping weight 5#/pair; Sm. Pkg.



PK10CS Weighted Pickleball Net Center Hold Down

Requires no floor attachment • Easy to adjust to official 34" center net height. Approx. shipping weight 4#; Sm. Pkg.





HOW TO SELECT YOUR NEXT SOCCER GOALS

Special Features of Bison Portable Aluminum Shootout™ Goals

Your program is not just like everyone else's. Your level of play, playing surface, goal removal requirements and budget all define your needs. Many programs that use brand name alone as their selection criterion often miss out on features that better fit their requirements. Bison offers a wide range of goals to meet the needs of college, high school, club, recreation and youth programs. Consider the following design features before you invest in your next pair of goals.



Manufactured or Locally Produced Goals

Over 80% of all portable goal tip over injuries and deaths reported in a recent study occurred with the use of homemade goals produced in shop class or at a local fabrication facility. Failure to understand and follow guidelines and testing requirements found in ASTM F2056 and ASTM F2673 often leads to lack of adequate tip over ballast or ground anchoring, unsuitable goal depth and heavy materials and construction that make goals top heavy. Off the shelf tubing commonly has sharp corners that affect safety. It is critical to purchase goals that have proper warning labels that also certify the goal meets the ASTM safety standards to reduce liability risk for your program.

Portability

Since many soccer fields serve double duty, portable goals make up a large percentage of the market. Even if the goal is not permanently attached to the ground, it might not be truly portable. Overall weight, use of rear stabilizing bars, transport systems and the quality of construction all contribute to the true portability. Common problems with hard to move portables include premature failure of welded corners and the potential for staff or player injury. Aluminum is the material of choice for portable goals. There are some lower cost steel portables but they are heavy, hard to move, prone to rust, and worst of all, dangerous if they tip over.

If you have full-time soccer fields, permanent or semi-permanent goals might fit your needs best. Generally, they offer a lower cost alternative with either steel or aluminum as viable options. Bison No-Tip Soccer goals are the perfect balance between portability, durability and safety.

Football Gooseneck Post Compatibility

Many high schools and collegiate soccer programs share facilities with football and other activities. It is vital that portable soccer goals are compatible with permanently installed football goalposts, allowing quick and easy conversion from football to soccer and back. All official size (24' x 8') Bison Shootout portable goals, **excluding those with the No-Tip feature**, allow placement in front of permanent football goal posts using the same goal line for both sports by moving the rear horizontal stabilizer bar forward or backward. This is especially critical for fields with permanently painted field markings.

Post Size Compatibility

NCAA, National High School Federation and FIFA rules require that front uprights and crossbars be no less than 4" and no more than 5" wide for official play. Round, square, rectangular or oval shaped materials are all permitted. Round goals are often selected by clubs that play by FIFA rules but many other programs like round as well. If you choose square or rectangular goals, pay attention to the corners on the tubes. The bigger the radius, the greater the player safety. Bison offers round, square and rectangular goals.

Goal Size

Official play at high school, college and many club levels requires 24' wide and 8' high goals. These are the goal opening dimensions. Youth goals are available in a variety of sizes and often local club rules, field availability or other factors will determine goal width. Generally, younger players use smaller fields and goals.

Competition 24' x 8':	U12 and up, high school, collegiate, international
Club Plus 21' x 7':	U10 - U12
Club 18½' x 6½':	U8 - U10
Youth 12' x 6½':	U6 - U8 and short-sided play
Bantam 9' x 4½':	U4 - U6 and short-sided play

Post Safety

Over the past few years, there has been an increasing awareness of soccer player injury statistics. While most injuries occur in the open field, injuries including concussions, broken bones, cuts and damaged teeth caused by player contact with goals are common.

If you prefer square or rectangular goals, look for manufacturers who use a large corner radius on all upright and crossbar tubes. Choose portable goals with the greatest back depth (10' on 24' x 8' goals) and provide premium anchoring or built-in ballast systems as a part of the package. Soccer is currently the most played team sport that does not require padding on equipment that players might come in contact with during competition. In the last few years, however, there has been a steady move in the direction of allowing and using upright padding to protect players and reduce program liability. All play that is governed by National High School Federation rules now allows post padding. Only Bison manufactures goals that can maintain the official 24' width with or without upright padding. Bison DuraSkin for Soccer padding has virtually no negative impact on ball rebound. To assure safety and avoid unnecessary liability, NEVER purchase goals that do not meet ASTM F2056 safety standards. Increase safety with goals that meet ASTM F2673.

Convenience

It's always easiest to buy in complete, ready-to-play packages. This insures all components are compatible. Features like transport systems and built-in safety ballast on portable goals make goal movement easier and safer. Net attachment methods are not all the same. Avoid systems that have loose clips or Velcro straps that get lost and goals with protruding net attachment hardware that presents a safety issue. Most programs prefer goals with built-in net attachment tracks like Bison's QwikTrack.

Durability/Warranty

When you invest in soccer goals, you want to be confident they will provide maintenance free service for many years. Aluminum goals have the advantage of a lifetime of rust free use. Some common aluminum goals, however, are prone to failure of welds where backstays attach to uprights. Big bulky goals get dragged across the field, putting stress on joints and resulting in the need for costly repairs. Bison's unique Torque Tested backstay attachment system, standard rear stabilizer bar and the inclusion of built-in transport and ballast systems on many goals allow Bison to offer an industry leading, **eight-year limited warranty** on 4" round and 4" square goals. Compare standard features and published warranties to get the most value for your investment.

Purchasing through a local dealer is not only friendly to your local economy but improves your service when you need help.



Torque Tested Backstay Attachment



No-Tip Transport/Ballast System On Many Styles



QwikTrack™ Easy and Dependable Net Attachment



Football Field Compatibility



Large Corner Safety Radius

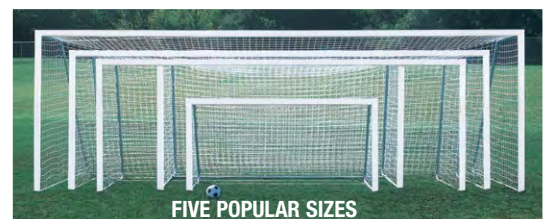

ShootOut™ No-Tip™ Portable Soccer Goals

No Loose Ballast  No Ground Anchors 

Easy to move and tip over safe at the same time... Bison No-Tip Portable Soccer Goals help you sleep well at night • No-Tip Goals meet all **ASTM F2056** and **ASTM F2673** standards for safety and performance without the use of loose ballast bags or undependable ground stakes that are often forgotten or improperly installed • Safety is the hallmark of these goals with extra backstay depth, radii on all square post corners and net attachment that has no hardware • Portable goals are meant to be truly portable so in addition to the No-Tip transport/ballast drums and lightweight aluminum post design, all Bison portable goals feature a unique Torque Tested backstay attachment design and rear backstay spreader bar that allows us to offer an industry leading **eight-year limited warranty** that includes typical failure of the vulnerable connection between uprights and the backstays • Available as 4" round or 4" square in three goal sizes, these goals meet or exceed all NCAA, National High School Federation and FIFA standards and rules • Bison's popular QwikTrack net attachment system allows net clips to stay connected securely to the net when net is removed from goal • No loose fasteners, Velcro straps, welded hooks or screw-on net clips are necessary • Goals have an extra thick textured white powder coat finish and backstays are galvanized • All ShootOut goals are sold in pairs • **See charts below.**

No-Tip Packages include goals with combination transport/ballast drums, competition white net, zippered net storage bag, rear horizontal stabilizer bars and QwikTrack net attachment kits. Customer supplies 250# of sand to fill ballast drums. All No-Tip packages meet **ASTM F2056** and **ASTM F2673**.

Value Packages include goals, auger style hold downs, rear stabilizer bar and QwikTrack net attachment kit (nets and No-Tip feature sold separately). All value packages meet **ASTM F2056**.

8-YEAR Limited Warranty



US Patent #8,579,736

See page 72 for No-Tip details on packages indicated in charts below.



See page 72 for Optional Player Safety Padding



THREE POPULAR SIZES

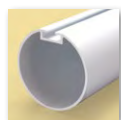

4" Round Goal Packages

Model	Package Type	Goal Package Size	Net Requirement	Ship Weight
SC2480PA40NT	No Tip	24' (w) x 8' (h) x 4' (t) x 10' (b)	Included	540#/pair
SC2480PA40E	Value	24' (w) x 8' (h) x 4' (t) x 10' (b)	SC100N*	435#/pair
SC2170PA40NT	No Tip	21' (w) x 7' (h) x 4' (t) x 7' (b)	Included	490#/pair
SC2170PA40E	Value	21' (w) x 7' (h) x 4' (t) x 7' (b)	SC080N	385#/pair
SC1865PA40NT	No Tip	18½' (w) x 6½' (h) x 4' (t) x 6½' (b)	Included	450#/pair
SC1865PA40E	Value	18½' (w) x 6½' (h) x 4' (t) x 6½' (b)	SC072N	345#/pair



4" Square Goal Packages

Model	Package Type	Goal Package Size	Net Requirement	Ship Weight
SC2480PA44NT	No Tip	24' (w) x 8' (h) x 4' (t) x 10' (b)	Included	540#/pair
SC2480PA44E	Value	24' (w) x 8' (h) x 4' (t) x 10' (b)	SC100N*	435#/pair
SC2170PA44NT	No Tip	21' (w) x 7' (h) x 4' (t) x 7' (b)	Included	490#/pair
SC2170PA44E	Value	21' (w) x 7' (h) x 4' (t) x 7' (b)	SC080N	385#/pair
SC1865PA44NT	No Tip	18½' (w) x 6½' (h) x 4' (t) x 6½' (b)	Included	450#/pair
SC1865PA44E	Value	18½' (w) x 6½' (h) x 4' (t) x 6½' (b)	SC072N	345#/pair

*If your 24' x 8' goals will be used on a football field under the football goal posts as shown, substitute SC106N net for SC100N net.





4" Round Extrusion No-Tip Transport System

Euro™ No-Tip™ Portable Futbol Goal

Euro styling, Bison No-Tip technology... make Euro goal a popular choice for soccer purists • Official 24' x 8' competition goal is constructed almost entirely of 4" diameter white aluminum powder coated extrusions with Bison exclusive QwikTrack net attachment system allowing net to be attached to uprights, crossbar and ground components • Bison patented No-Tip combination safety ballast and transport system insure easy transport and dependable safety with no need to remember to add weight bags, ground anchors or other anti-tip over devices • European style backstays support net at top • Choose from 3 sizes in chart below, each meeting or exceeding **ASTM F-2056** and **ASTM F-2673** • Goals include nets, net storage bag, net attachment clips and No-Tip system • Sold in pairs • Eight-year limited warranty.



Model	Package Type	Size	Net Requirement	Ship Weight
SC2480PA40EURO	No Tip	24' (w) x 8'(h) x 4'(t) x 10' (b)	Included	500#/pair
SC2170PA40EURO	No Tip	21' (w) x 7' (h) x 4' (t) x 7' (b)	Included	475#/pair
SC1865PA40EURO	No Tip	18½' (w) x 6½' (h) x 4' (t) x 6½' (b)	Included	425#/pair

All Aluminum ShootOut™ No-Tip™ Portable Soccer Goals

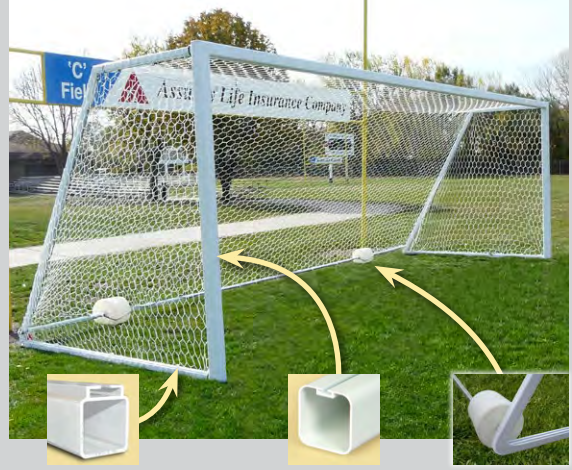

2" Square QwikTrack™ Side and Rear Rails 4" Square Large Corner Safety Radius No-Tip Transport/Ballast System

100% Aluminum... And a whole lot more • The latest development in Bison's super strong line of super safe soccer goals • Fully welded aluminum 4" square uprights and 2" square backstay assemblies feature extra welded gusset plates at critical corner connections to make them virtually unbreakable • Bison's QwikTrack™ net attachment system allows easy net attachment to upright, crossbar, bottom sides and rear of goal • Only Bison offers patented No-Tip™ integrated ballast and transport system insuring both safety and easy goal movement without ground anchors or loose ballast • All Aluminum No-Tip goals meet all NCAA, National High School Federation, FIFA, **ASTM F2056** and **ASTM F2673** rules and specifications • Specially designed extrusions have extra heavy wall thickness and large corner safety radii to guarantee both durability and safety • All Bison ShootOut soccer goals feature a super thick bright white textured powder coated finish and carry an **eight-year limited warranty** • 12" wide molded polyethylene drums roll easily even in tall, wet or muddy grass and provide permanent safe ballast when properly filled with sand by customer at the time of installation • All ShootOut goals are sold in pairs • See chart below.



Optional Player Safety Padding

Model	Package Type	Size	Net Requirement	Ship Weight
SC2480PA44XL	No Tip	24' (w) x 8' (h) x 4' (t) x 10' (b)	Included	550#/pair
SC2170PA44XL	No Tip	21' (w) x 7' (h) x 4' (t) x 7' (b)	Included	500#/pair
SC1865PA44XL	No Tip	18½' (w) x 6½' (h) x 4' (t) x 6½' (b)	Included	460#/pair

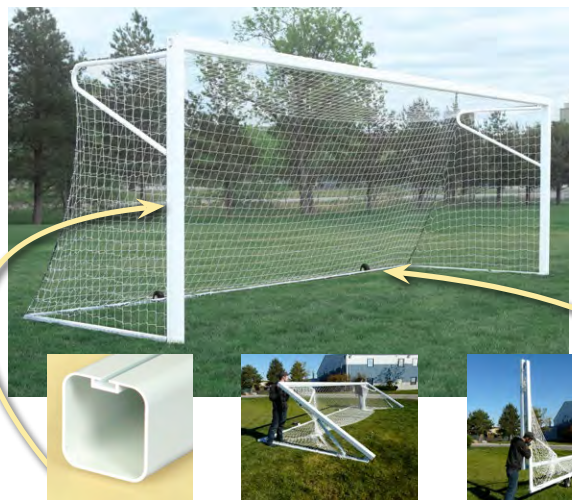

4" Square Large Corner Safety Radii Support goal as it is lowered. Roll on 12" semi-pneumatic swivel casters.

Fold and Store™ Portable ShootOut™ Soccer Goals

When space is at a premium... Fold and Store Shootout soccer goals are the right fit • Many of the same great features as Bison's standard 4" square aluminum portable soccer goals but with the added convenience of being able to simply collapse into a 10" thick package when not in use • Choose from three popular sizes • No loose hardware or tools required • Net stays attached if desired • Meets **ASTM F2056** • Sold in pairs including nets, net clips, 12" semi-pneumatic transport wheels and auger style anchors • Order four optional SC50B ballast bags for use on artificial turf • See chart below.



Optional Player Safety Padding

Model	Size	Net Requirement	Ship Weight
SC2480PA44F	24' (w) x 8' (h) x 4' (t) x 10' (b)	Included	500#/pair
SC2170PA44F	21' (w) x 7' (h) x 4' (t) x 7' (b)	Included	475#/pair
SC1865PA44F	18½' (w) x 6½' (h) x 4' (t) x 6½' (b)	Included	425#/pair



ShootOut™ 2" x 4" Portable Aluminum Soccer Goals

5-YEAR
Limited Warranty



SC2480PA24 Shown with Optional SC24PP Safety Padding

2" x 4" portable aluminum soccer goals offer many of the quality features available on Bison 4" square and 4" round goals but are designed to offer a durable option at a budget conscious price... Safety is never compromised at Bison and our 2" x 4" goals include the same extra deep backstays as our 4" square and 4" round goals and have no hardware protruding from the goal face • Durability features include exclusive Torque Tested backstay attachment and heavy steel galvanized backstays including rear horizontal stabilizing bar • Net attachment is easy and dependable with Bison's QwikTrack™ system that eliminates the need for protruding metal clips, holes drilled in the structure, Velcro or wire ties • Select one of five available sizes from the chart below • Official size 24' x 8' goal meets all NCAA, National High School Federation and FIFA rules.



No-Tip Packages include goals, nets, QwikTrack net attachment kit and Bison's exclusive No-Tip transport and ballast system. Customer supplies 250# of sand to fill ballast drums. No-Tip packages meet **ASTM F2056** and **ASTM F2673**.

Value Packages include goals, net attachment kit (SC72N) and auger-style hold downs (SC04GA) and meet **ASTM F2056**.



FIVE POPULAR SIZES



2" x 4" Goal Packages

Model	Package Type	Size	Net Requirement	Ship Weight
SC2480PA24NT	No Tip	24' (w) x 8' (h) x 4' (t) x 10' (b)	Included	500#/pair
SC2480PA24E	Value	24' (w) x 8' (h) x 4' (t) x 10' (b)	SC100N*	430#/pair
SC2170PA24NT	No Tip	21' (w) x 7' (h) x 4' (t) x 7' (b)	Included	450#/pair
SC2170PA24E	Value	21' (w) x 7' (h) x 4' (t) x 7' (b)	SC080N	380#/pair
SC1865PA24NT	No Tip	18½' (w) x 6½' (h) x 4' (t) x 6½' (b)	Included	430#/pair
SC1865PA24E	Value	18½' (w) x 6½' (h) x 4' (t) x 6½' (b)	SC072N	360#/pair
SC1265PA24E	Value	12' (w) x 6½' (h) x 4' (t) x 6½' (b)	SC060N	210#/pair
SC0945PA24E	Value	9' (w) x 4½' (h) x 2' (t) x 4½' (b)	SC050N	240#/pair



See page 72 for No-Tip details on packages indicated.



See page 72 for Optional Player Safety Padding

WARNING!
Never allow hanging or climbing on soccer goal net or framework as serious injury may occur from tip over or collapse. All portable goals must be securely anchored to the ground to avoid injury from tip over. **Bison has free warning labels available.**

2" x 4" ShootOut™ Portable Aluminum Soccer Goals Premium Features



Patented No-Tip Transport/Ballast System on No-Tip Package

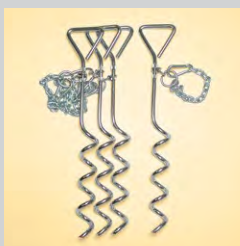

Premium Auger-Style Anchors on Value Package

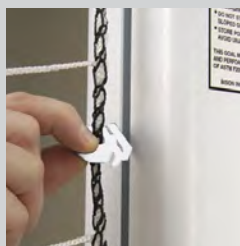

QwikTrack™ Easy and Dependable Net Attachment on all Packages



Football Field Compatibility

*If your 24' x 8' goals will be used on a football field under the football goalposts as shown, substitute SC106N net for SC100N net.





ShootOut™ 4" Square Aluminum Permanent/Semi Permanent Soccer Goals

Just what you would expect from Bison, goals that are durable, affordable and easy to install.

Bison permanent/semi permanent 4" square, powder coated soccer goals are now constructed of aluminum extrusions for a lifetime of rustproof service... These goals include Bison's premium QwikTrack net attachment system popular on our aluminum portable goals eliminating loose Velcro net attachment • Goals can be permanently installed in concrete or be removable with the purchase of SC44S ground sleeves • Available in five sizes • Order optional European 4' backstays to add top depth to goals • Compatible nets indicated on chart are ordered separately • All in-ground soccer goals have a five-year limited warranty and ship by truck.



Torque Tested Backstay Attachment

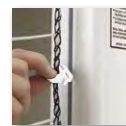

QwikTrack™ Easy and Dependable Net Attachment



Model	Goal Size	No Top Depth Net	4' Top Depth Net	Shipping Weight
SC2480IGA	Competition 24'(w) x 8'(h)	SC095N	SC100N	275#/pair
SC2170IGA	Club Plus 21'(w) x 7'(h)	SC075N	SC080N	265#/pair
SC1865IGA	Club 18½'(w) x 6½'(h)	SC071N	SC072N	235#/pair
SC1265IGA	Youth 12'(w) x 6½'(h)	SC055N	SC060N	215#/pair
SC0945IGA	Bantam 9'(w) x 4½'(h)	SC045N	N/A	185#/pair

Order Nets Separately



SC2480IGA Shown with Optional SC02BSA Backstays

SC02BSA European Backstays

Add 4' top backstay to any Bison in-ground goals... 1.66" diameter white steel tube construction • Requires purchase of 4' top depth nets (see chart above) • Not compatible with SC0945IGA goals • Order one pair per goal; two pair per field. Approx. shipping weight: 20#/pair; Truck



FIVE POPULAR SIZES



SC2480IGA

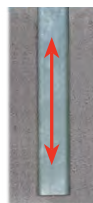

SC44S Ground Sleeves

4" square, 24" deep sockets install in 8" diameter minimum 30" deep concrete footing for easy removal of goals when not in use... Sockets are extruded aluminum and include cap to keep out debris • Order two sleeves per goal (four per field). Approx. shipping weight: 5# each; Small Pkg.



FREE!
Mesh Storage Bag with Each Pair of Nets

With Top Depth

Super High Tenacity Polypropylene Mesh



With No Top Depth

Woven Knotless HTPP Soccer Nets

These premium nets are designed specifically for Bison soccer goals but can be used on any soccer goal with comparable top and bottom depth... Constructed of heavy super high tenacity polypropylene (HTPP) multifilament rachel knotless netting, these nets are non-abrasive for superior durability and safety • These white mesh nets have heavy rope edges to facilitate proper attachment to goal and field • Each pair of nets comes with a free mesh carry bag for easy transport or storage between games or during the off season • Soccer nets are not returnable once opened unless defective • Ninety-day warranty.

SC00EB Mesh Equipment Bag

This 30" x 48" sturdy fine mesh nylon bag will hold team equipment, balls or soccer nets... Convenient top drawstring. Approx. shipping weight: 1#; Sm. Package.

Nets with Specified Top Depth

Model	Mesh Diameter	Mesh Shape	Width	Height	Top Depth	Bottom Depth	Shipping Weight
SC100N	4mm	Octagon	24'	8'	4'	10'	Approx. 21#/pair; Sm. Pkg.
SC106N	4mm	Square	24'	8'	4'	6'	Approx. 20#/pair; Sm. Pkg.
SC080N	4mm	Square	21'	7'	4'	7'	Approx. 12#/pair; Sm. Pkg.
SC072N	4mm	Square	18.5'	6.5'	4'	6.5'	Approx. 11#/pair; Sm. Pkg.
SC060N	4mm	Square	12'	6.5'	4'	6.5'	Approx. 9#/pair; Sm. Pkg.
SC050N	4mm	Square	9'	4.5'	2'	4.5'	Approx. 6#/pair; Sm. Pkg.

SC100N nets have octagon mesh. All other nets are 4" square mesh.

Nets with No Top Depth

Model	Mesh Diameter	Mesh Shape	Width	Height	Top Depth	Bottom Depth	Shipping Weight
SC095N	4mm	Square	24'	8'	0'	8'	Approx. 12#/pair; Sm. Pkg.
SC075N	4mm	Square	21'	7'	0'	7'	Approx. 10#/pair; Sm. Pkg.
SC071N	4mm	Square	18.5'	6.5'	0'	6.5'	Approx. 9#/pair; Sm. Pkg.
SC055N	4mm	Square	12'	6.5'	0'	6.5'	Approx. 7#/pair; Sm. Pkg.
SC045N	4mm	Square	9'	4.5'	0'	4.5'	Approx. 5#/pair; Sm. Pkg.





ShootOut™ Combo Aluminum Football/Soccer/Rugby Goals

When soccer and football teams share space...Combo Goals are the answer • Constructed of weatherproof 4" square aluminum extrusions • Nets attach with popular Bison exclusive QwikTrack system • 4" square upright and crossbar extrusions have large corner radii for superior player safety and have a bright white, textured powder coated finish • Official 24' (w) x 8' (h) soccer goals and official 10' high football crossbar and 10' uprights that can be installed either at 23'4" high school width or 18'6" college width • Order FB10EXT-WT to extend uprights from 10' to 20' height • Uprights can also be installed at rugby width for added versatility • Choose in-ground permanent/semi permanent or portable (see details below) • Eight-year limited warranties • Sold in pairs but available individually.

SC2480IGAFOB Permanent Semi Permanent Combo Goals

Install goals permanently in concrete footings or install using optional SC44S ground sleeves to allow easy removal...Order SC095N net separately for standard Combo Goals or order SC100N for goals with optional European backstays. Approx. shipping weight: 500#/pair; Truck

SC02BSA Optional European 4' Backstays

Add 4' top backstay to any Bison in-ground aluminum soccer goal...White powder coated finish • Order one pair per goal. Approx. shipping weight: 20#/pair; Sm. Pkg.

SC2480PA44FB Portable Combo Goals

Add the convenience of portability and built-in No-Tip ballast system to the versatility of Combo Goals...Bison No-Tip system insures safety without the inconvenience of ballast bags, ground anchors or other anchor systems that are often forgotten, lost, discarded or ineffective • The rear ballasts double as transport wheels allowing movement on and off the field to improve space utilization. *Note: Due to the added weight of the football crossbar and uprights, goal transport typically requires four people* • Order SC100N nets separately. Approx. shipping weight: 750#/pair; Truck

SC44S Ground Sleeve

4" square, 24" deep sockets...Install in 8" diameter minimum x 30" deep concrete footing for easy removal of in-ground goals when not in use • Order two sleeves per goal (four per field). Approx. shipping weight: 5#/each; Sm. Pkg.



COMPLETE FOOTBALL AND SOCCER PACKAGES

Complete Football and Soccer Combination Goal Packages

Make your buying decision easy and save money, too...Buy your football goal posts and soccer goals in guaranteed compatible packages • The perfect solution for new schools and renovated fields • Package includes all the goals and accessory components to play high school or collegiate soccer and football including:

- Bison Perfect Goal™ Football Goalposts - 1 pair
- Goalpost Wind Direction Streamers (4) - 1 set
- Weighted Football Goal Line End Markers (4) - 1 set
- Competition Football Goalpost Padding (16 color options) - 2
- One-Color Football Safety Pad Lettering - 2
- ShootOut™ Official 24'x 8' Portable Aluminum Soccer Goals - 1 pair
- Tip and Roll Wheel Kit
- Ground Anchor Kit for Natural Turf
- Goal Ballast Bags for Artificial Turf
- 4mm Soccer Nets - 1 pair
- Soccer Net Storage Bag - 1
- Ground Spike Style Soccer Corner Flags - set of 4
- Corner Flag Storage Bag - 1

SAVE \$\$\$



Tip and Roll Wheel Kit



Note: Packages will not allow soccer play on 120 yard soccer fields.

Package Model #	Level of Play	Football Goalpost Gooseneck Diameter and Extension	Football Goalpost Color	Soccer Goal Aluminum Tubing Size
PKGFBSCCG-SY	Collegiate	5 9/16" diameter x 96" setback	Safety yellow	4" round
PKGFBSCHS-WT	High School	5 9/16" diameter x 72" setback	White	4" square
PKGFBSCHSV-WT	High School	4 1/2" diameter x 60" setback	White	2" x 4"





SC04SM ScoreMore™ Training Targets

The name says it all...most goals are scored in the far reaches of the soccer goal • Practice makes perfect and this set of 4 velcro-on bright orange targets allow players to perfect their skills on any make, model or size of goal • Targets can be installed or removed in less than 2 minutes and are designed to instantly spring back into position when practice kick makes contact so no need to reset, reducing down practice time • Targets are approximately 16" x 18" each and can be attached to any location on the face of the goal • Fit neatly in a convenient storage and carrying bag • One-year limited warranty. Approx. shipping weight: 3#, Sm. Pkg.

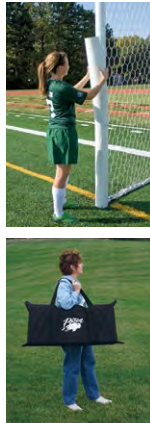

Soccer Upright Post Padding

Protect your players from injuries caused by contact with goal uprights...Football goal posts, volleyball uprights and basketball backboards are all required to be padded by NCAA and National High School Federation rules • Bison's revolutionary DuraSkin™ molded soccer padding virtually eliminates concerns about the effect of post padding on play • Isn't it time that soccer players are given the same safety considerations as players of other sports? • Choose from premium DuraSkin padding or from our vinyl covered youth/practice padding in the chart below • In all cases the padding covers the bottom 72" of the posts for improved players safety at all levels of play • One kit covers both posts on one goal • DuraSkin meets NHSF rules interpretation 1-4-1.

National High School Federation 2004-2005 Soccer Rule Interpretation
Rule 1-4-1: The vertical portion of the goal post may be padded with commercially manufactured material for soccer goals. This material shall be white, have a maximum thickness of 1", be a minimum of 72" high and shall be properly secured. No markings other than a single manufacturer's identification/logo may appear on the goal post padding.

Goal Upright Size	DuraSkin Premium Padding	Shipping Wtg.	Youth Practice Padding	Shipping Wgt.
4" Square	SC44PP	20#/Kit	SC00PP	10#/Kit
4" Round or Elliptical	SC40PP	15#/Kit	SC01PP	10#/Kit
2" x 4" Rectangular	SC24PP	16#/Kit	SC00PP	10#/Kit



Soccer Corner Flags

Official corner flags in zippered storage bag...Choose SC06CF with ground spikes for natural turf or SC06CFW with sand fillable base for artificial turf or indoor use • Sets of 4. Approx. shipping weight 20#/set; Sm. Pkg.

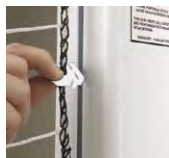

SC72NC QwikTrack™ Replacement Net Attachment Clips

Compatible with all Bison aluminum soccer, Futsal, field hockey and team handball goals...72 clips attaches two nets to two goals. Approx. shipping weight 2#/pkg.; Sm. Pkg.



SC10 Velcro® Soccer Net Attachment Kit

Attach any manufacturer's nets to any manufacturer's goals...Double side Velcro straps, ground stakes and a storage bag make net attachment easy • Attaches nets to two goals. Approx. shipping weight 4#, Sm. Pkg.



SC04GA Ground Anchor Kit

Auger style anchors are superior to straight ground anchors...Proper use complies with NCAA and NFHS rules regarding anchoring and tip over of portable soccer goals • Set of 4 (two per goal). Approx. shipping weight 5#/set; Sm. Pkg.



SCNOTIP No-Tip™ Retrofit Kit

Retrofit Bison and most other brands and styles of portable soccer goals to improve tip over and transport safety...12" wide molded polyethylene drums each hold approximately 60# of customer supplied sand for ballast and act as rollers for easy transport • Contact Bison for information on compatibility with existing goals • One kit retrofits two goals • Five-year limited warranty. Approx. shipping weight 50#/kit; Sm. Pkg.



SC34BI Soccer Steel Bar Ballast (not shown)

Add dependable permanent weight to any rear tubular stabilizer tube...17/16" diameter solid steel bar, 34" long • Each weighs 16# • Order enough to fill the length of the rear stabilizer bar on your portable goals. Approx. shipping weight 16# each; Sm. Pkg.



Tip and Roll Wheel Retrofit Kit

Add a front transport system to virtually any make or model of soccer goal...10" wheels flip forward for use and back for play • One kit retrofits two goals • Order SC04WKU for universal kit to fit any goal with 15/8" - 2" diameter backstays • Order SC04WK for use on Bison Shootout soccer goal value packages. Approx. shipping weight 20#/set; Sm. Pkg.



SC06DK Soccer Skill Practice Disks

8" diameter durable orange plastic • Set of 24. Approx. shipping weight 3#/set; Sm. Pkg.

SC50B Ballast Bag

Safety first...Use in place of ground anchors on artificial turf fields or as preferred anchoring method • Requires two per goal • Black vinyl bag with zippered sides • Capacity for 70# of sand or gravel (customer provided). Approx. shipping weight: 8#/each; Sm. Pkg.

During Transport



Easy PerfectGoal™ Installation

Set Post



Attach "T" Adapter to Crossbar



Slide "T" Adapter Onto Gooseneck



Tip Crossbar to Level and Clamp



Insert Upright Assembly Onto Crossbar



Rotate Upright to Vertical



Bolt Upright Into Place



Level then Drill and Bolt "T" Adapter In Place

PerfectGoal™ for High School and College

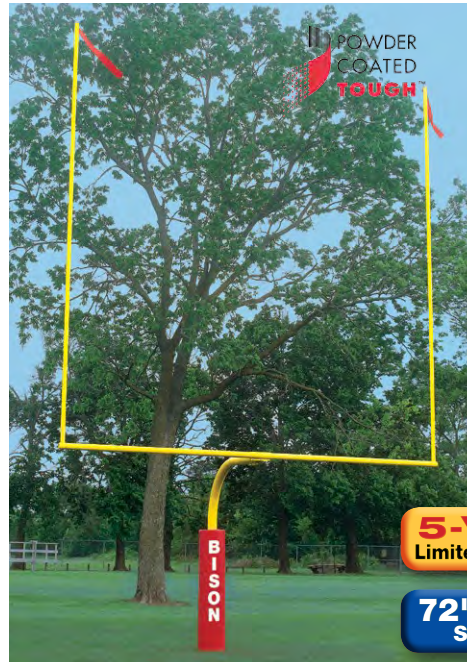

5-YEAR Limited Warranty

72" or 96" Setback

FB55CG-SY Shown with Optional FBCPP-SC Padding, ABC52 Lettering and FBWDS Streamers

5⁹/₁₆" Gooseneck Goalposts

These are the heaviest Bison goalposts...Choose 96" or 72" setback • 48" ground bury • 5⁹/₁₆" O.D. schedule 40 pipe is bent then powder coated • All Bison gooseneck goalposts feature Bison's exclusive PerfectGoal design for precise vertical and horizontal alignment and uncommon ease of installation • 4¹/₂" steel tube crossbar and 20' long, 2³/₈" diameter aluminum uprights • Order FB10EXT to increase upright height from 20' to 30' • Use with FB55S ground sleeves if desired • Ships in four pieces plus hardware per goal • Sold in pairs but available individually. See chart for approximate shipping weights.

Model and Description	Setback	Weight
FB55HS-SY High School Safety Yellow	72"	1200#/pair; Truck
FB55HS-WT High School White	72"	1200#/pair; Truck
FB55CG-SY Collegiate Safety Yellow	72"	1075#/pair; Truck
FB55CG-WT Collegiate White	72"	1075#/pair; Truck
FB58HS-SY High School Safety Yellow	96"	1250#/pair; Truck
FB58HS-WT High School White	96"	1250#/pair; Truck
FB58CG-SY Collegiate Safety Yellow	96"	1125#/pair; Truck
FB58CG-WT Collegiate White	96"	1125#/pair; Truck

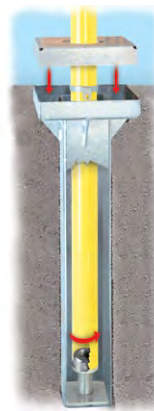

PerfectGoal™ Adjustable Height Ground Sleeves

These sleeves allow the removal of gooseneck style goalposts on multi-purpose fields...The only goalpost sleeve in the industry that allows accurate adjustment of the crossbar height to official 10' • Hot dip galvanized heavy wall steel base • 4" of total crossbar height adjustment • Built-in anti-rotation device • Aluminum cover to finish socket both when installed and removed • Requires minimum 30" diameter x 53" deep excavation • Order two per field • Some assembly required • Use only

with Bison goalposts • Order **FB55S** for 5⁹/₁₆" goal posts and **FB45S** for 4¹/₂" goal posts. Approx. shipping weight: 120# each; Sm. Pkg.



FB55HSCG-WT Shown with Optional FBCPP-FG Padding, ABC52 Lettering and FBWDS Streamers

5⁹/₁₆" Combination High School/College Goalposts

High school football Friday night, college game on Saturday afternoon...No problem with these versatile goals • 5⁹/₁₆" diameter OD Schedule 40 steel goosenecks are available with either 96" or 72" setback • The 4¹/₂" steel tube crossbar has specially designed expandable uprights for safe and easy one man adjustment • Includes all the features that have made Bison Perfect Goal football goal posts popular • 20' aluminum uprights • Use with optional FB55S ground sleeves if desired • See chart for approximate shipping weights.

Model and Description	Setback	Weight
FB55HSCG-SY High School/College Safety Yellow	72"	1350#/pair; Truck
FB55HSCG-WT High School/College White	72"	1350#/pair; Truck
FB58HSCG-SY High School/College Safety Yellow	96"	1400#/pair; Truck
FB58HSCG-WT High School/College White	96"	1400#/pair; Truck



FB45HS-WT Shown with Optional FBCPP-RY Padding and ABC52 Lettering

4¹/₂" Gooseneck Goalposts

Popular 4¹/₂" gooseneck styling and Bison's exclusive PerfectGoal design makes these goalposts an excellent value...Posts bury 48" into the ground for stability or use FB45S ground sleeves for removable installation • Posts have 60" setback and 20' long aluminum uprights • Crossbars are 4¹/₂" steel tube • Ships in four pieces plus hardware per goal • Sold in pairs but available individually. See chart for approximate shipping weights.

Model and Description	Dimensions	Weight
FB45HS-SY High School 4 ¹ / ₂ " Safety Yellow	60"	1050#/pair; Truck
FB45HS-WT High School 4 ¹ / ₂ " White	60"	1050#/pair; Truck
FB45CG-SY Collegiate 4 ¹ / ₂ " Safety Yellow	60"	925#/pair; Truck
FB45CG-WT Collegiate 4 ¹ / ₂ " White	60"	925#/pair; Truck





**5-YEAR
Limited Warranty**



FB35-GV H-Style Galvanized Goalposts

This simple design is our most affordable goalpost option... Features 3½" heavy wall galvanized uprights and crossbars • Posts bury

directly into the ground approximately 3' for excellent rigidity • Official high school 23'4" wide x 10' high uprights or crossbar can be easily field cut and installed at 18'6" college width • Great for practice fields, youth fields and budget conscious programs • Rain caps keep water out of posts • Sold in pairs but available individually. Approx. shipping weight: 815#/pair; Truck



FBRUGBY Official Rugby Goals

Goals as tough as the players who play the game... Built to last • Heavy wall 3½" diameter galvanized steel uprights and crossbars • Uprights extend 27' above the playing surface and bury 3' into the ground for lasting installation in all climates • Crossbar spreads upright to official 18' 4" width • Height can be adjusted in the field to make installation easy and precise • Galvanized surface can be painted in the field if desired • Rain caps keep water out of upright posts • Goals meet all applicable rules • Sold in pairs. Approx. shipping weight: 1,000#/pair; Truck



FOOTBALL PADDING & ACCESSORIES



Practice Kicking Cage

Kick until your leg is tired without ever chasing the ball... Punters, place kickers or soccer players can practice in confined spaces, indoors or out • Sturdy 1" diameter, tubular, powder coated blue steel framework • Pop-together, push button assembly • Heavy mesh catch net • 6' high x 4' wide opening creates a big target • Folds flat for storage when not in use • One-year limited warranty.

FB100KC Practice Kicking Cage with Net Approx. shipping weight: 30#; Sm. Pkg.



FB04EM Weighted Football Goal Line End Markers

Bright, safe and durable... Bottom weighted end zone markers require no ground stakes or sockets to install, just place on end line • Weighted markers tip with the slightest player contact for maximum safety • Heavy florescent orange vinyl covered foam • Meets all

NCAA and National High School Federation rules • Sold in sets of four • One-year limited warranty. Approx. shipping weight: 11#; Sm. Pkg.



FBWDS Wind Direction Streamers

Official 4" wide x 42" long, weather resistant streamers... Includes hardware to attach to 2⅜" diameter uprights without drilling • Durable orange outdoor flag material, double stitched • Can be used on other size

uprights by drilling and bolting • Sold in sets of four. Approx. shipping weight: 2#; Sm. Pkg.

Upright Extensions for Football Gooseneck Goalposts

Increase the upright height from 20' to 30' on 5⅞" or 4⅝" Gooseneck Goalposts or from 10' to 20' on Aluminum Combination Soccer/Football Goals with these 10' extensions... Includes four 10' aluminum upright extenders and adapter hardware • Order one kit per field • Specify white (FB10EXT-WT) or safety yellow (FB10EXT-SY) • Contact your Bison Product Specialist for details. Approx. shipping weight: 60#/kit; Truck



FBCPPW Sport Pride™ Football Goalpost Padding Wrap

Spruce up your field and strut your stuff... Easy-to-install heavy vinyl graphic wraps are custom made to fit your existing goalpost pads or can be ordered at the same time as Bison FBCPP goalpost padding • Full color graphic printing options including Bison QwikPrint designs or almost any image and lettering • To order, specify padding height (Bison padding is 72"), measure around the circumference of the pad when on pole and provide design, colors and lettering • Consult the Bison Art Department for design options • Includes one hour of design time, additional design time is billed as BNART by the hour • Velcro attachment • **Includes convenient transport and storage bag** • Sold in pairs. Approx. shipping weight: 20#/pair; Sm. Pkg.

FBCPP Competition Goalpost Padding

Super thick 5" foam covered with weatherproof vinyl in your choice of 16 school colors... Velcro strap closures • Protects players to a height of 72" • Meets all NCAA and National High School Federation rules • Designed to fit all goal posts to 59⅞" diameter and 4" square.

Approx. shipping weight: 18#/each; Sm. Pkg. Ships Oversize



Custom Lettering and Logos for Bison Padding

Show your school spirit with customized padding... Almost any Bison vinyl padding surface can be lettered with up to 10 letters for one low price • All lettering and logos will be sized and spaced by the Bison Art Department based on the size and shape of the padding and the number and style of letters or logo requested • Order multiple ABC51, ABC52, ABC53 for application on multiple sides of padding • Available only on Bison padding.

ABC52 Standard One-Color Lettering

Maximum of 10 letters... Choose from letter styles A, B, C and D • Must select from colors shown on page 102.

ABC53 Second Color Letter Outline Option

Optional addition to letter styles A and B only • Must select from colors shown on page 102.

ABC51 Standard One-Color Logo

Send a logo to Bison Art Department prior to placing order... Artwork subject to pre-approval and hourly BNART artwork charges may apply • Must select from colors shown on page 102 • 12" x 12" maximum size.





LC300 Easy Goal™ Official Aluminum Lacrosse Goals

Never sacrifice quality and durability for convenience... Easy Goal has it all

- Meets all NCAA and National High School Federation rules for competitive play
- Special aluminum extrusions with Bison's exclusive Qwik Track net attachment system and push button knock down design make this goal easy to transport, set up or tear down in less than five minutes
- All components are rust-proof aluminum or stainless steel for a lifetime of weatherproof use
- Easy Goal comes complete with 6mm mesh net, Qwik Track net attachment clips, hold down stakes for natural turf, ballast bags for artificial turf fields and zippered transport bags
- Official 6' (h) x 6' (w) x 7' (d) opening
- Orange powder coated finish
- Sold in pairs
- Nets not returnable once opened
- Three-year limited warranty.

Approx. shipping weight: 75#/pair; Sm. Pkg.



Easy Pull Pin Disassembly



QwikTrack™ Easy and Dependable Net Attachment



Zippered Transport Bag

LC200 Official Steel Competition Lacrosse Goals

These goals meet all NCAA and National High School Federation rules for competition play... Popular flat iron style base allows use indoors or outdoors on any surface

- 1½" (1.9" O.D.) schedule 40 pipe framework has thick ground bars allowing sturdy ground staking or use of ballast bags to stabilize
- Orange powder coated finish
- Includes four ground anchors
- 6' (h) x 6' (w) x 7' (d) opening
- Sold in pairs
- Nets included
- Nets not returnable once opened
- One-year limited warranty.

Approx. shipping weight: 145#/pair; Sm. Pkg.



LC050N Official Lacrosse Nets

Designed to fit Bison lacrosse goals but will fit most official lacrosse goals... 6mm white knotless webbing

- Sold in pairs
- Sports nets are not returnable once opened unless determined to be defective.

Approx. shipping weight: 25#/pair; Sm. Pkg.

HK500 Competition Ice Hockey Goal

No need for cold feet when you choose Bison... The game is rough, our goals are tough

- 2⅜" OD schedule 40 pipe form the official 72" (w) x 48" (h) x 34" (d) goal mouth for unsurpassed durability
- 100% welded construction
- 2" OD rear support structure
- Red powder coated finish
- Sold in pairs complete with HK050N nets, net attachment laces and HK500P padding set
- Nets not returnable once opened
- Five-year limited goal warranty.

Approx. shipping weight: 300#/pair; Truck

HK500P Complete Padding Set

For HK500 Ice Hockey Goals... Included in HK500 above but can be ordered separately for replacement

- Designed specifically to fit Bison hockey goals
- Includes lower puck cushions, top shelf pad and necessary attachment components
- One set for one goal, 2 required per rink.

Approx. shipping weight: 30#/each, Sm. Pkg.



HK050N Ice Hockey Net

6mm nylon construction... Designed for a perfect fit on Bison's HK500 goals

- Includes attachment laces
- Sports nets are not returnable once opened unless determined to be defective.

Approx. shipping weight: 30#/pair; Sm. Pkg.

HK50U Qwik Release Urethane Locator Rods

Sold in sets of 4. Approx. shipping weight: 2#/set of 4; Sm. Pkg.



FH200 Outdoor Field Hockey Goals

Durable design for high level competition...100% rustproof aluminum with premium black weatherproof ¼" UHMW kick boards • White powder coated finish • Easy and dependable QwikTrack net attachment • Official size meets all USFHA and National High School Federation rules • Complete package includes two goals, two nets and net attachment kit • Nets not returnable once opened • Two-year limited warranty. Approx. shipping weight: 300#/pair; Truck

FH200N Field Hockey Nets

Meets all association rules for official goals...12' (w) x 7' (h) x 4' (t) x 4' (b) square mesh with heavy braided corners and edges • Replacement net for FH200 and most other manufacturers' similar official field hockey goals • Includes two nets • **Sports nets are not returnable once opened unless determined to be defective** • One-year limited warranty. Approx. shipping weight: 15#/pair; Sm. Pkg.

FH200WK Wheel Kit for Field Hockey Goals (not shown)

Transport with ease...Take your goals to and from the field • 10" diameter wheels mount permanently to the back of field hockey goal frames to increase convenience and reduce risk of player injury or goal damage • Some drilling of goal required for installation • Includes wheels and hardware for two goals. Approx. shipping weight: 40#/set; Sm. Pkg.



QwikTrack™ Easy and Dependable Net Attachment

SCFUTSAL Official Futsal Goal

A great goal for a great game...2 meter (approximately 6'7") high and 3 meter (approximately 9'10") wide goal meets official rules • 100% aluminum construction with a durable white powder coated finish • 8cm square (approximately 3" x 3") aluminum extrusion uprights and crossbars have large corner radii for player safety and Bison's exclusive QwikTrack net mounting system • Standard rear horizontal stabilizer bar adds durability and stability • Complete package includes two goals with rear stabilizer bars, two nets, QwikTrack net clips, indoor rubber floor protectors and two ballast bags • Nets not returnable once opened • Two-year limited warranty. Approx. shipping weight: 175#/pair; Truck



8 cm Square Tubing



Net Attachment Clips

SC03PP Futsal Safety Padding

Protect futsal players from contact with the corner posts...Vinyl-covered, ½" thick padding covers full 79" height of posts • Velcro attachment • Sold in kits to protect one goal • Order two kits per court.

Approx. shipping weight: 10#/kit; Sm. Pkg.



STFUTSAL Shown with Optional SC03PP Safety Padding

SCTEAMHB Official Team Handball Goal

Goal meets all official handball rules...2 meter x 3 meter opening • Constructed of 3" square aluminum extrusion tubing • Large safety radii on all corners of tubing corners • Features fast and easy QwikTrack net attachment • Anti-skid floor protectors and portable ballast bags and net included • Sold in pairs • Nets not returnable once opened • Two-year limited warranty Approx. shipping weight: 175#/pair; Truck

shipping weight: 175#/pair; Truck

SCFUTSALN Futsal and Team Handball Net

Net is designed for Bison futsal goal but can be used on any futsal goal with the same dimensions...4" square mesh constructed of 3mm diameter netting • 3 meter (9' 10") wide and 2 meter (6' 7") high • 80cm (31½") top depth and 100cm (39⅜") bottom depth • **Sports nets are not returnable once opened unless determined to be defective.**

Approx. shipping weight: 8#/pair; Sm. Pkg.

SC50B Ballast Bag

Safety first...Black vinyl bag with zippered sides • Capacity for 70# of sand or gravel (customer provides) • One ballast bag included with each Bison futsal and team handball goal • Order SC50B for additional bags.

Approx. shipping weight: 8#/each; Sm. Pkg.



SCTEAMHB



Easy Store™ Portable Bleachers

See pages 78-81 for outdoor seating.



BL11503A



Easy Store™ Indoor Bleachers

Portable indoor bleachers provide a mobile solution to seating needs in a wide range of indoor applications and can be used outdoors when required... When in use, Easy Store bleachers rest on non-marking rubber feet • Just lift front to tilt bleachers onto stable 3" diameter transport casters • Choose from 7½', 15' or 21' lengths in various heights • Heavy-duty 2" x 10" anodized aluminum seat planks • Choose fully welded hot dip galvanized steel or aluminum structure • Planks have end caps for a finished look without sharp edges • High grade zinc plated hardware • See page 79 for information on powder coated seat planks • Five-year limited warranty on structure, two-year limited warranty on planks.

Approximate Indoor/Outdoor Bleacher Dimensions

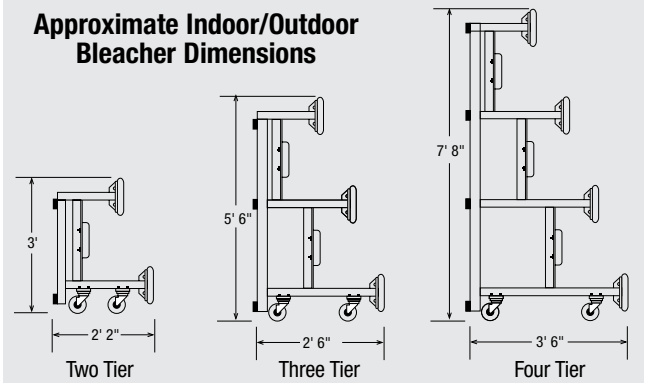

WARNING!

The four tier Bison bleachers shown on this page meet some but not all codes established for bleachers by various agencies. Bison assumes no responsibility for customer selection of bleachers that do not meet local or statewide codes for guard rails, kickboards or other standards.

Length	Tiers	Seating Capacity	Approx. Overall Dimension	Aluminum Structure Model #	Aluminum Structure Shipping Weight	Galvanized Steel Structure Model #	Galvanized Steel Structure Shipping Weight
7½'	2	10	2' 2" (h) x 3' (d) x 7½' (l)	BLI0702AA	120#	BLI0702A	150#
7½'	3	15	2' 6" (h) x 5' 6" (d) x 7½' (l)	BLI0703AA	130#	BLI0703A	180#
7½'	4	20	3' 6" (h) x 7' 8" (d) x 7½' (l)	BLI0704AA	190#	BLI0704A	240#
15'	2	20	2' 2" (h) x 3' (d) x 15' (l)	BLI1502AA	195#	BLI1502A	225#
15'	3	30	2' 6" (h) x 5' 6" (d) x 15' (l)	BLI1503AA	250#	BLI1503A	325#
15'	4	40	3' 6" (h) x 7' 8" (d) x 15' (l)	BLI1504AA	340#	BLI1504A	425#
21'	2	28	2' 2" (h) x 3' (d) x 21' (l)	BLI2102AA	280#	BLI2102A	350#
21'	3	42	2' 6" (h) x 5' 6" (d) x 21' (l)	BLI2103AA	350#	BLI2103A	475#



See page 77 for Indoor Tip and Roll indoor bleachers.

Portable Bleachers



BLO1503A

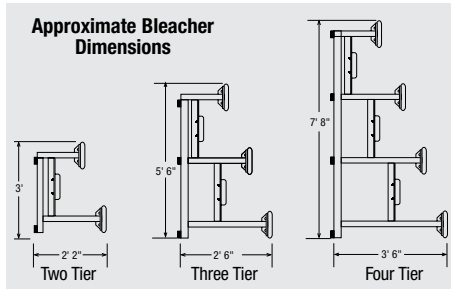

BLO1503A Shown with Optional BL15SEAT-SC Seat Planks

Weatherbeater™ Outdoor Bleachers

These outdoor bleachers are built for a lifetime of dependable, trouble-free sports seating... Weatherbeater bleachers come with recycled plastic ground runners to keep support framework raised from grass or dirt • Recycled runners will not rot like wood runners used by other manufacturers • Available in 7½', 15' or 21' lengths in either 3 or 4 tier heights • 2 tier bleachers are only available in 15' lengths • Heavy-duty 2" x 10" anodized aluminum seat planks • Choose hot dip galvanized or 100% aluminum welded support structures • Planks have end caps for a finished look without sharp edges • High grade zinc plated hardware • See page 79 for information on powder coated seat planks • Five-year limited warranty on structure, two-year limited warranty on planks.



BLO1504AXL

WARNING!
The four tier Bison bleachers shown on this page meet some but not all codes established for bleachers by various agencies. Bison assumes no responsibility for customer selection of bleachers that do not meet local or statewide codes for guard rails, kickboards or other standards.



BLO1504AXL Shown with Optional BL15SEAT-RY Seat Planks

Weatherbeater™ Premium Outdoor Bleachers

An extra measure of comfort and safety... Same basic features as outlined above • The addition of an extra foot rest plank and heel kick panel not only improve safety but also provide comfort, child control and reduced dropped or lost loose objects like jackets, purses and backpacks • Add color planks (see page 79) to customize your field • Five-year limited warranty on structure, two-year limited warranty on planks.

PLANK CONFIGURATION STRUCTURE CONSTRUCTION				Standard Aluminum Structure		Standard Galvanized Steel Structure		Premium Aluminum Structure		Premium Galvanized Steel Structure	
Length	Tiers	Seating Capacity	Approx. Overall Dimension	Model #	Shipping Weight	Model #	Shipping Weight	Model #	Shipping Weight	Model #	Shipping Weight
7½'	3	15	2' 6" (h) x 5' 6" (d) x 7½' (l)	BLO0703AA	Approx. 155# Truck	BLO0703A	Approx. 195# Truck	BLO0703AXLAA	Approx. 195# Truck	BLO0703AXL	Approx. 245# Truck
7½'	4	20	3' 6" (h) x 7' 8" (d) x 7½' (l)	BLO0704AA	Approx. 210# Truck	BLO0704A	Approx. 265# Truck	BLO0704AXLAA	Approx. 270# Truck	BLO0704AXL	Approx. 335# Truck
15'	2	20	2' 2" (h) x 3' (d) x 15' (l)	BLO1502AA	Approx. 200# Truck	BLO1502A	Approx. 225# Truck	BLO1502AXLAA	Approx. 250# Truck	BLO1502AXL	Approx. 300# Truck
15'	3	30	2' 6" (h) x 5' 6" (d) x 15' (l)	BLO1503AA	Approx. 275# Truck	BLO1503A	Approx. 345# Truck	BLO1503AXLAA	Approx. 375# Truck	BLO1503AXL	Approx. 470# Truck
15'	4	40	3' 6" (h) x 7' 8" (d) x 15' (l)	BLO1504AA	Approx. 370# Truck	BLO1504A	Approx. 465# Truck	BLO1504AXLAA	Approx. 520# Truck	BLO1504AXL	Approx. 650# Truck
21'	3	42	2' 6" (h) x 5' 6" (d) x 21' (l)	BLO2103AA	Approx. 375# Truck	BLO2103A	Approx. 470# Truck	BLO2103AXLAA	Approx. 520# Truck	BLO2103AXL	Approx. 645# Truck
21'	4	56	3' 6" (h) x 7' 8" (d) x 21' (l)	BLO2104AA	Approx. 500# Truck	BLO2104A	Approx. 635# Truck	BLO2104AXLAA	Approx. 710# Truck	BLO2104AXL	Approx. 890# Truck



Player Benches

Benches are available as either in-ground fixed models or wide-base, freestanding portables... Select benches with or without a backrest • Bison player benches have your choice of 100% welded aluminum or steel steel support structure • Steel structures have a silver/gray powder coated finish • 21' length for fourteen player capacity, 15' for ten players or 7½' for five players • Four 2" square supports on 21', three supports on 15' and two supports on 7½' • All steel parts have a silver/gray powder coated finish • 2" x 10" x .08" minimum cross section anodized aluminum seats and backs • Planks have end caps for a finished look without sharp edges • Fixed models require a 30" concrete footing to install in-ground for lasting, safe, weatherproof seating • Portable models are constructed to provide a nearly tip-proof bench to transfer from football field to soccer, baseball or softball fields as seasons change • Portable benches can be used with or without rubber feet provided, can be anchored to ground or can be bolted down to courtside surfaces • Five-year limited warranty on steel structure, two-year limited warranty on all seats and backs.



BNP1501BAA

Player Benches with Backrest



BNP1501BA



BNP1501BAA with optional powder coated backrest

Length	Seating	Fixed or Portable	Backrest	Legs/ Supports	All Aluminum		Steel Structure	
					Model #	Shipping Weight	Model #	Shipping Weight
21'	14	Portable	Yes	4	BNP2101BAA	Approx. 110#, Truck	BNP2101BA	Approx. 160#, Truck
21'	14	Fixed	Yes	4	BNF2101BAA	Approx. 100#, Truck	BNF2101BA	Approx. 150#, Truck
15'	10	Portable	Yes	3	BNP1501BAA	Approx. 75#, Truck	BNP1501BA	Approx. 115#, Truck
15'	10	Fixed	Yes	3	BNF1501BAA	Approx. 75#, Truck	BNF1501BA	Approx. 110#, Truck
7½'	5	Portable	Yes	2	BNP0701BAA	Approx. 45#, Truck	BNP0701BA	Approx. 70#, Truck
7½'	5	Fixed	Yes	2	BNF0701BAA	Approx. 45#, Truck	BNF0701BA	Approx. 65#, Truck

Powder Coated Aluminum Planks

Show your school colors on Bison's 4', 7½', 15' and 21' benches or bleachers... Simply substitute your choice of royal, scarlet, navy, forest green, black or white planks for standard anodized aluminum seats that are included with Bison aluminum player benches, Weatherbeater bleachers and Easy Store bleachers • Choose any combination of colors for any quantity of seat planks • Each powder coated plank will incur an upcharge based on length • Order BL04SEAT1-XX for 4' planks, BL07SEAT1-XX for 7½' planks, BL15SEAT1-XX for 15' planks and BL21SEAT1-XX for 21' planks • Orders of 25 or more planks can be powder coated in a wider variety of colors (allow six weeks).



RY-Royal SC-Scarlet NY-Navy

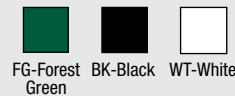

FG-Forest Green BK-Black WT-White

Player Benches without Backrest



BNF0701A

Length	Seating Capacity	Fixed or Portable	Backrest	Legs/ Supports	All Aluminum		Steel Structure	
					Model #	Shipping Weight	Model #	Shipping Weight
21'	14	Portable	No	4	BNP2101AA	Approx. 60#, Truck	BNP2101A	Approx. 85#, Truck
21'	14	Fixed	No	4	BNF2101AA	Approx. 60#, Truck	BNF2101A	Approx. 90#, Truck
15'	10	Portable	No	3	BNP1501AA	Approx. 45#, Truck	BNP1501A	Approx. 65#, Truck
15'	10	Fixed	No	3	BNF1501AA	Approx. 45#, Truck	BNF1501A	Approx. 65#, Truck
7½'	5	Portable	No	2	BNP0701AA	Approx. 30#, Truck	BNP0701A	Approx. 40#, Truck
7½'	5	Fixed	No	2	BNF0701AA	Approx. 30#, Truck	BNF0701A	Approx. 40#, Truck





Covered No-Tip Portable Sports Benches

Popularized on soccer fields... but perfect for any outdoor sport to protect players from hot sun and wet weather • Our popular No-Tip combination ballast and transport system also used on our No-Tip soccer goals allows easy transport and when combined with our base leg extenders virtually eliminates tip over risk even in windy areas • No-Tip drums are filled with sand (provided by customer) • Cover is 14 oz. outdoor durable vinyl • Choose full color graphic printed bench covers with artwork created with the help of our talented design staff or select one of 17 solid color unprinted vinyls • All aluminum bench structures have a white textured powder coated finish • Seat planks and backs are heavy, clear anodized 2" x 10" aluminum extrusions but can be powder coated to customize your benches (see page 79) • Covered benches are available 7½', 15' and 21' lengths and carry a two-year limited warranty • Select the right model from the chart below.



BNP15CVGRAA

BNP15CVSHAA



Length	Seating Capacity	Approx. Overall Dimensions	Graphic Cover	Solid Color Cover	Shipping Weight
21'	14	21' (l) x 78" (h) x 45" (d)	BNP21CVGRAA	BNP21CVSHAA	155# Truck
15'	10	15' (l) x 78" (h) x 45" (d)	BNP15CVGRAA	BNP15CVSHAA	125# Truck
7½'	5	7½' (l) x 78" (h) x 45" (d)	BNP07CVGRAA	BNP07CVSHAA	85# Truck

BNP1500XL **Big B**™ Portable Football Team Benches



BNP1500XL

When your players are big... Select **Big B** benches

- Heavy-duty 2" square tubular steel structure supports even the heaviest loads
- Double wide planks provide a 20" deep seat
- Rear shelf is 10" wide and can be used for water bottles, trainer supplies or is sturdy enough to act as elevated player seating
- Seat, seat back and rear shelf planks are extruded aluminum and available in your choice of clear anodized aluminum, royal, scarlet, black, white, navy or forest green powder coating
- Steel structure is available in your choice of silver/gray, black or white powder coating
- 2" molded rubber risers separate structure from wet turf to improve durability

- All **Big B** benches are 15' long and covered by a **lifetime limited warranty**.
Approx. shipping weight: 260#; Truck



BNP0401BCA School Color 4' Player Bench

A popular choice, colorful and comfortable... These 4' portable benches will seat 2 or 3 in style • Choose seat and backrest planks in any combination of clear anodized aluminum, royal, scarlet, black, white, navy or forest green with your choice of silver/gray, black or white powder coated legs at no additional charge • 2" x 10" x .08" aluminum seats and backs

• All player bench structures are constructed of 2" square aluminum tubing and include rubber feet to allow indoor use without damaging floors and to keep legs from deteriorating in wet grass • Five-year limited warranty.

Approx. shipping weight: 60#/each; Sm. Pkg.



TN500BNP



BNP0401BCA



Build Your Own Bleachers (or Benches)

In this case, BYOB is not what you think... It means more seating for less money • Bison provides the structure and the hardware • You provide the 2" x 10" x 16' lumber • The result is seating for your program with saving up to 30% • Bleacher structure has hot dipped galvanized finish and bench structures have silver/gray powder coated finish for outdoor durability • See Bison bleacher and bench description for other details • Available only in the bench and bleacher models listed below.

Model #	Description	Customer Supplied 2" x 10" x 16' Planks	Seating Capacity	Shipping Weight
BYOB161	16' Portable Player Bench with Back	2	10	Approx. 55# Truck
BYOB163	16' 3 Tier Outdoor Bleacher	5	30	Approx. 200# Truck
BYOB164	16' 4 Tier Outdoor Bleacher	7	40	Approx. 250# Truck

Increase School Spirit with Team Colors

Powder Coated Aluminum Planks

Show your school colors on Bison's 4', 7½', 15' and 21' benches or bleachers... Simply substitute your choice of royal, scarlet, navy, forest green, black or white planks for standard anodized aluminum seats that are included with Bison aluminum player benches, Weatherbeater bleachers and Easy Store bleachers

• Choose any combination of colors for any quantity of seat planks • Each powder coated plank will incur an upcharge based on length • Order BLO4SEAT1-XX for 4' planks, BLO7SEAT1-XX for 7½' planks, BL15SEAT1-XX for 15' planks and BL21SEAT1-XX for 21' planks • Orders of 25 or more planks can be powder coated in a wider variety of colors (allow six weeks).

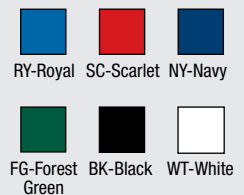



Fixed Height Ultimate™ Series



Choose 12 Ga. Steel, 12 Ga. Aluminum,
½" Tempered Glass or ½" Clear
Unbreakable Polycarbonate Backboard

Heavy-Duty Goal with
Double 5/8" Solid Rim and
No-Fail Netlock System or
Outdoor Flex Goal

Massive
6" Square
Steel Pole

60" Safe Play Area
Also available with
72" Safe Play Area

Select from
Black or Hot Dip
Galvanized
Finishes

40" Deep
Bury

Original Ultimate

Try an Ultimate System on your most demanding outdoor court and you'll never need to buy another basketball system...

From the massive 6" square, 3/16" wall pole that buries a full 40" into the ground for incredible stability, to the tip of the Ultimate goal that carries an unconditional lifetime warranty, these systems are meant to take the abuse common on today's playgrounds • All fixed height Ultimate systems feature a full 60" setback for maximum player safety and offer optional backboard and pole padding • Order BA870AXL to upgrade from standard 60" to 72" extension on any system below at an additional cost • 42" x 60" boards are available in white powder coated steel or aluminum • 42" x 72" perforated or solid steel backboards give your court two more long-term Ultimate options • For the serious player, select an official size 42" x 72" backboard of clear tempered glass or clear unbreakable polycarbonate • Poles are available in black powder coating or hot dip galvanized for high humidity and coastal salt spray applications • Choose system with Ultimate goal covered by the unconditional lifetime warranty or popular outdoor breakaway goal • See chart below for the wide range of fixed height Ultimate systems to fit your facility's needs.

**LIFETIME
Warranty**

See PR15 and PR17 Ultimate Jr.™ for similar features on a downsized system perfect for smaller budgets.

BA871-BK Shown with Optional BA870PP-BK Pole Padding

The Ultimate for durability, playability and value!

Ultimate Model	Double-Sided Version	Backboards	Goals	Pole Finish	Optional Backboard Padding	Warranty	Single-Sided Shipping Weight	Double-Sided Shipping Weight
V BA871-BK	BA872-BK	42" x 60" Steel	BA39U Ultimate	Black	BA60U-BK	Lifetime Limited Functional	Approx. 500# Truck	Approx. 800# Truck
V BA871XL-BK	BA872XL-BK	42" x 72" Steel	BA39U Ultimate	Black	BA72U-BK	Lifetime Limited Functional	Approx. 525# Truck	Approx. 850# Truck
BA874-BK	N/A	42" x 72" Perforated Steel	BA39U Ultimate	Black	BA72U-BK	Lifetime Limited Functional	Approx. 525# Truck	N/A
BA871A-BK	BA872A-BK	42" x 60" Aluminum	BA39U Ultimate	Black	BA60U-BK	Lifetime Limited Functional	Approx. 410# Truck	Approx. 620# Truck
BA871A-GV Best for Coastal Salt Spray Locations	BA872A-GV	42" x 60" Aluminum	BA39U-GV Ultimate	Hot Dip Galvanized	BA60U-BK	Unconditional Lifetime	Approx. 410# Truck	Approx. 620# Truck
BA873-BK	N/A	42" x 72" Glass	BA32 Breakaway	Black	BA72U-BK	Pole: Lifetime Limited Functional Goal: 1-Year Limited	Approx. 550# Truck	N/A
BA873U-BK	N/A	42" x 72" Polycarbonate	BA32 Breakaway	Black	BA72U-BK	Pole: Lifetime Limited Functional Goal: 1-Year Limited	Approx. 480# Truck	N/A

Order BA870PP-BK for optional pole padding on single systems, BA872PP-BK for optional padding on double sided systems.





Perforated Steel



60" Safe Play Area
72" Safe Play Area Optional

POWDER COATED TOUGH™



Any Ultimate playground system can be double-sided. Contact Bison for details.

BA874-BK
Shown with
Optional
BA870PP-BK
Pole Padding

Coastal Aluminum



60" Safe Play Area
72" Safe Play Area Optional

BA871A-GV

Unbreakable Polycarbonate



UNBREAKABLE
60" Safe Play Area
72" Safe Play Area Optional

BA873U Shown with Optional BA870PP-BK Pole Padding and BA72U-BK Backboard Padding

PR15 Ultimate™ JR Fan Aluminum Playground System

Steel and lots of it...The 5" square, 1/8" wall, steel pole is buried 36" deep for superior rigidity • 4" square extension arm places backboard 36" from pole for player safety • 35½" x 54" cast aluminum backboard has an orange border and shooter's square • Breakaway goal direct mounts through backboard into extension arm to virtually eliminate stress on the board • Order BA870JRPP for optional pole padding • Ten-year limited warranty. Approx. shipping weight: 265#; Truck



36" Safe Play Area

PR15

PR17 Ultimate™ JR Rectangular Steel Playground System

Large 42" x 60" Ultimate steel backboard on a rigid 5" square, 11 ga. steel pole...36" Safeplay™ area • White powder coated backboard with orange shooter's square • Heavy-duty exterior grade breakaway goal • Order BA870JRPP for optional 1" thick, 72" high pole padding • Ten-year limited warranty. Approx. shipping weight: 350#/each; Truck



PR17



Adjustable Height Ultimate™ Series

When outdoor playgrounds, camps or resorts demand durability, adjustability and playability – only Bison has a system with gymnasium quality features... The Ultimate Adjustable features a massive, 6" square, 3/16" wall post with a full 40" bury not found on comparable systems from other manufacturers • Deeper bury provides resistance to frost heave in cold climates and improves pole rigidity during aggressive slam dunk action • **Choose official size 42" x 72" clear backboard of tempered glass, bullet proof clear polycarbonate or 42" x 60" steel backboard** • Height adjusts between 7½' and 10' • Backboard is positioned 50" from the pole at official 10' goal height • Safe play area extends to 60" at 9', 64" at 8', for greater safety at lowered goal height when it is most needed during slam dunk action • The "off-glass" goal mounting eliminates 98% of stress from player contact with the rim • Goal height is easily adjusted from the playing surface using a hand crank with features similar to Bison's gymnasium goal height adjusters • Adjustment mechanism features an enclosed stainless steel lead screw crank • All steel components have a black powder coated or a zinc plated finish • Bison BA33U double-rim flex goal • Entire system, excluding height adjustment crank, has a **lifetime limited functional warranty** regardless of backboard option selected.

Choose 42" x 72" Glass, 42" x 72" Clear Polycarbonate or 42" x 60" Steel Backboard

Double-Rim Flex Goal with No-Fail Netlock System

50" Safe Play Area at 10'

Removable Hand Crank for Height Adjustment

Massive 6" Square Steel Pole

40" Deep Bury

PR98U with Unbreakable Polycarbonate Backboard Shown with Optional BA72U-BK Backboard Padding and BA870PP-BK Pole Padding



PR98S

Order Bison BA32 Outdoor Flex Goal (With One-Year Warranty) to Substitute a Traditional Single Rim for the More Durable Double Rim Breakaway Goals Standard with These Packages



Contact Bison for optional removable pedestal base on PR98U, PR98G, or PR98S



50" Safe Play Area at 10'

POWDER COATED TOUGH™

Ultimate Model	Backboard	Goal	Pole Finish	Optional Backboard Padding	Warranty	Shipping Weight
PR98U	42" x 72" Polycarbonate	BA33U	Black	BA72U-BK	Lifetime Limited Functional	Approx. 500# Truck
PR98G	42" x 72" Glass	BA33U	Black	BA72U-BK	Lifetime Limited Functional	Approx. 560# Truck
PR98S	42" x 60" Steel	BA33U	Black	BA60U-BK	Lifetime Limited Functional	Approx. 530# Truck

Order BA870PP-BK for optional pole padding.

PR16 Power Adjust™ Playground System

A heavy-duty hand crank easily adjusts this system from 7½' to official 10' goal height... Excellent for playgrounds where a wide variety of ages play • 35½" x 54" cast aluminum backboard has an orange border and shooter's square and **unconditional lifetime warranty** • Safe play area is 50" at official 10' goal height • Safe play area increases to 62" at 8' goal height, allowing maximum mobility under the backboard • 5" square, 1/8" wall steel vertical pole • Heavy-duty flex goal • Removable pedestal "J" bolt base • Order BA870JRPP for optional pole padding • Five-year limited warranty on pole • One-year limited warranty on goal and crank. Approx. shipping weight: 415#; Truck



Removable Pedestal Base





PR94U Shown With Optional BA79UPP Pole Padding



Removable Pedestal Base



PR95U With Optional BA870JRPP Pole Padding

PR94U QwikLift™ 4" Outdoor System

Perfect for daycare playgrounds, camps or other outdoor facilities that cater to a wide age range of basketball enthusiasts...Height adjustable from 7½' to 10' with an easy to operate rear crank • Can be padlocked at any rim height with customer provided lock • 36" safe play area when the goal is at official 10' height • 4" square, 11 ga. removable pedestal mount pole • Black powder coated finish • Durable competition grade breakaway goal with heavy net • Order BA79UPP for optional pole safety padding • Unbreakable 36" x 54" clear polycarbonate backboard with white border and shooters square • **Unconditional lifetime warranty** on backboard • One year on other components.

Approx. shipping weight: 310#/each; Truck

PR95U QwikLift™ 5" Outdoor System

Same great systems as PR94U except with heavier 5" square, 11 ga. pole and larger 36" x 60" backboard • Order BA870JRPP for optional pole safety padding • One-year limited warranty on entire system except **unconditional lifetime warranty** on polycarbonate backboard. Approx. shipping weight: 350#/each; Truck

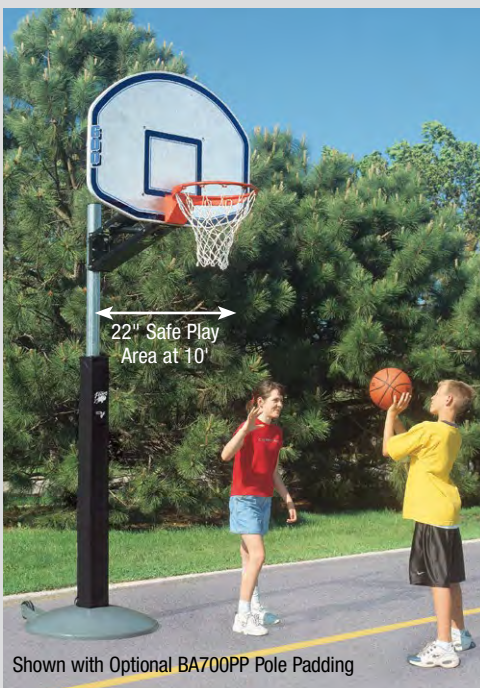

Shown with Optional BA700PP Pole Padding

QwikChange™ Playground Systems

Popular playground features at a popular price...Heavy galvanized 3½" steel pole • 36" x 48" molded graphite backboard and flex goal adjusts from 7½' to 10' in 6" increments • QwikChange design requires only a pole to change height from the ground • Choose permanent in-ground or portable system • Great for camps, daycares, church parking lots or anywhere kids of all ages gather to play basketball • One year limited warranty.

PR12 QwikChange™ Permanent

36" ground bury...Optional BA700PP pole safety padding. Approx. shipping weight: 165#; Truck

BA801 QwikChange™ Portable

Factory installed 350# of ballast...Built-in transport wheels • Order BA801BP and BA700PP for base and pole safety padding. Approx. shipping weight: 450#; Truck



Tilt and Roll



Easy Height Adjustment

BA801BP Base Padding

Improve safety with this specially designed pad that covers 360° around the base of the BA801 portable...1" thick foam with sewn cover in black vinyl • Velcro attachment. Approx. shipping weight: 10#; Sm. Pkg.

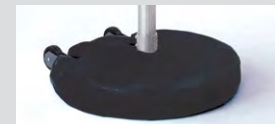



All packages on this page have a 72" safe play area, 48" ground bury and lifetime limited pole warranty.

The heaviest gooseneck systems available are on our Mega-Duty BA780 pole...

Superior rigidity, superior durability and greater safe play area make this pole a must where play is rough • 5 9/16" O.D., hot dip galvanized steel pipe • 72" safe play area • Goal mounts directly through backboard to pole to virtually eliminate stress on backboard when hanging occurs • Heavy, 1 5/8" backboard braces • 48" in-ground bury • Add additional BA700PP pole padding for increased player safety • Order BA780 pole and components separately or in popular packages described below • **Lifetime limited warranty on pole.**

PR74 Package on BA780 Pole
BA42UC Backboard - Official 42" x 72" clear, bulletproof polycarbonate • Heavy extruded aluminum framework • Official white shooter's square and border • **Lifetime limited warranty.**

BA32 Goal - Outdoor flex goal • Designed to withstand playground abuse • One-year limited warranty. Approx. PR74 shipping weight: 500#; Truck

PR75 Package on BA780 Pole
BA475SS Backboard - Durable, rust-free aluminum • Fan-shaped 35 1/2" x 54" • White powder coated finish • Heavy support ribs • Orange shooter's square and border • **Lifetime limited warranty.**

BA39U Goal - Ultimate playground goal • Double, 5/8" steel rim • No-fail netlock adds strength and eliminates netlock breakage • 3/16" thick steel box-style backplate and rim supports • Accepts nylon (included) or chain nets • **Unconditional lifetime replacement warranty.**

Approx. PR75 shipping weight: 360#; Truck **No Substitutions.**

PR76 Package on BA780 Pole
BA495 Backboard - Heavy-duty mounting support structure • 12 ga. steel skin • Fan-shaped 39" x 54" • White powder coated finish • Ten-year limited warranty.

BA39U Goal - Ultimate playground goal • Double, 5/8" steel rim • No-fail netlock adds strength and eliminates netlock breakage • 3/16" thick steel box-style backplate and rim supports • Accepts nylon (included) or chain nets • **Unconditional lifetime replacement warranty.**

Approx. PR76 shipping weight: 405#; Truck

PR77 Package on BA780 Pole
BA47 Backboard - Ultimate playground backboard • Rectangular 42" x 60" • Safety rolled edges • Heavy-duty 12 ga. steel skin • White powder coated finish • **Lifetime limited warranty.**

BA39U Goal - Ultimate playground goal • Double, 5/8" steel rim • No-fail netlock adds strength and eliminates netlock breakage • 3/16" thick steel box-style backplate and rim supports • Accepts nylon (included) or chain nets • **Unconditional lifetime replacement warranty.**

Approx. PR77 shipping weight: 450#; Truck

PR78 Package on BA780 Pole
BA407U Backboard - Bulletproof • Unbreakable clear polycarbonate • Rectangular 42" x 54" • Extruded aluminum framework • White shooter's square and border • **Lifetime limited warranty.**

BA32 Goal - Outdoor flex goal • Designed to withstand playground abuse • One-year limited warranty. Approx. PR78 shipping weight: 440#; Truck

PR79 Package on BA780 Pole
BA472PC Backboard - Official 42" x 72" size • Perforated style backboard popular on inner city playgrounds • 12 ga. steel skin with heavy steel rear framework • White powder coated finish • Safety rolled edges • 10-year limited warranty.

BA39U Goal - Ultimate playground goal • Double, 5/8" steel rim • No-fail netlock adds strength and eliminates netlock breakage • 3/16" thick steel box-style backplate and rim supports • Accepts nylon (included) or chain nets • **Unconditional lifetime replacement warranty.**

Approx. PR79 shipping weight: 470#; Truck

PR87 Package on BA780 Pole
BA472 Backboard - Rectangular official size 42" x 72" backboard • Safety rolled edges • Heavy-duty 12 ga. steel skin • White powder coated finish • **Lifetime limited warranty.**

BA39U Goal - Ultimate playground goal • Double, 5/8" steel rim • No-fail netlock adds strength and eliminates netlock breakage • 3/16" thick steel box-style backplate and rim supports • Accepts nylon (included) or chain nets • **Unconditional lifetime replacement warranty.**

Approx. PR87 shipping weight: 475#; Truck



PR77
Shown with
Optional BA700PP
Pole Padding

72" Safe Play Area



PR76



TUBE & CONDUIT®

A PART OF atkore

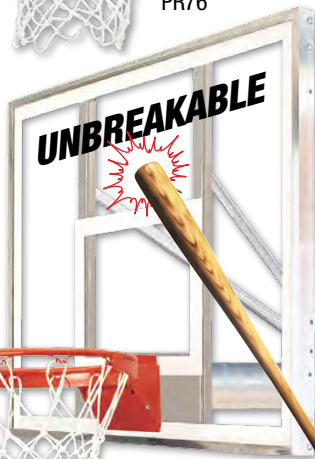

UNBREAKABLE

PR74 (72" wide)
PR78 (54" wide)



PR75



PR79



Twin Mega-Duty Packages

If a single mega-duty 5⁹/₁₆" pole is mega duty, imagine the performance you'll get from Twin Mega-Duty playground basketball systems...With the addition of a Bison official size 42" x 72" competition glass backboard and breakaway goal, you'll have a system that will match or even exceed the playability of any indoor competition system in the industry • Optional features include FBCPP post safety padding and BA72U-BK backboard padding • Great system for camps, parks or school grounds where gymnasium-like features are desired for their outdoor facilities • Choose from 72" safe play area or extended 96" safe play area.

PR99 Package

on BA780T Twin Gooseneck Pole BA42XL Backboard - Competition grade 1/2" tempered glass with bright white, fire impregnated shooter's square and border • Official 42" x 72" size • 72" safe play area • Heavy-duty outdoor flex goal has no contact with the backboard • Heavy aluminum extrusion and steel framework • **Lifetime limited warranty.** Approx. shipping weight: 785#, Truck

PR99XL Package

on BA780TXL Twin Gooseneck Pole Same system as PR99 except Twin Gooseneck pole system has 96" of safe play area instead of 72" for even greater safety during aggressive, high speed play. Approx. shipping weight: 865#, Truck

Extended Mega-Duty Packages

on BA780XL Pole with 96" Safe Play Area

5⁹/₁₆" O.D. pole rigidity now with 8' safe play area...Improves player safety • Some playground locations where play is expected to reach maximum speed and aggressiveness want and need the same 96" safe play area as required in professional, collegiate and top program high school play • Same 5⁹/₁₆" hot dipped galvanized pole as Mega-Duty systems but with added 24" extended safe play area • 48" ground bury • 1⁵/₈" backboard braces • Direct mount goal design • Add optional FBCPP pole padding for increased player safety • Order BA780XL pole and components separately or in packages described below with compatible backboards and goals • **Lifetime limited warranty on pole.**

PR75XL Package

BA475SS Backboard - Durable, rust-free aluminum • Fan-shaped 35 1/2" x 54" • White powder coated finish • Heavy support ribs • Orange shooter's square and border • **Lifetime limited warranty.**

BA39U Goal - Ultimate playground goal • Double, 5/8" steel rim • No-fail netlock adds strength and eliminates netlock breakage • 3/16" thick steel box-style backplate and rim supports • Accepts nylon (included) or chain nets • **Unconditional lifetime replacement warranty.** Approx. PR75XL shipping weight: 400#, Truck

PR77XL Package

BA47 Backboard - Ultimate playground backboard • Rectangular 42" x 60" • Safety rolled edges • Heavy-duty 12 ga. steel skin • White powder coated finish • **Ten-year limited warranty.**

BA39U Goal - Ultimate playground goal • Double, 5/8" steel rim • No-fail netlock adds strength and eliminates netlock breakage • 3/16" thick steel box-style backplate and rim supports • Accepts nylon (included) or chain nets • **Unconditional lifetime replacement warranty.** Approx. PR77XL shipping weight: 490#, Truck

PR79XL Package

BA472PC Backboard - Official 42" x 72" size • Perforated style backboard popular on inner city playgrounds • 12 ga. steel skin with heavy steel rear framework • White powder coated finish • Safety rolled edges • **10-year limited warranty.**

BA39U Goal - Ultimate playground goal • Double, 5/8" steel rim • No-fail netlock adds strength and eliminates netlock breakage • 3/16" thick steel box-style backplate and rim supports • Accepts nylon (included) or chain nets • **Unconditional lifetime replacement warranty.** Approx. PR79XL shipping weight: 510#, Truck

PR87XL Package

BA472 Backboard - Rectangular official size 42" x 72" backboard • Safety rolled edges • Heavy-duty 12 ga. steel skin • White powder coated finish • **Lifetime limited warranty.**

BA39U Goal - Ultimate playground goal • Double, 5/8" steel rim • No-fail netlock adds strength and eliminates netlock breakage • 3/16" thick steel box-style backplate and rim supports • Accepts nylon (included) or chain nets • **Unconditional lifetime replacement warranty.** Approx. PR87XL shipping weight: 515#, Truck



PR99 Shown with Optional FBCPP Pole Padding and BA72U-BK Backboard Padding



PR75XL

PR79XL

PR77XL



All packages on this page have a 48" safe play area or optional new 60" safe play area, 48" ground bury and 25-year pole warranty.

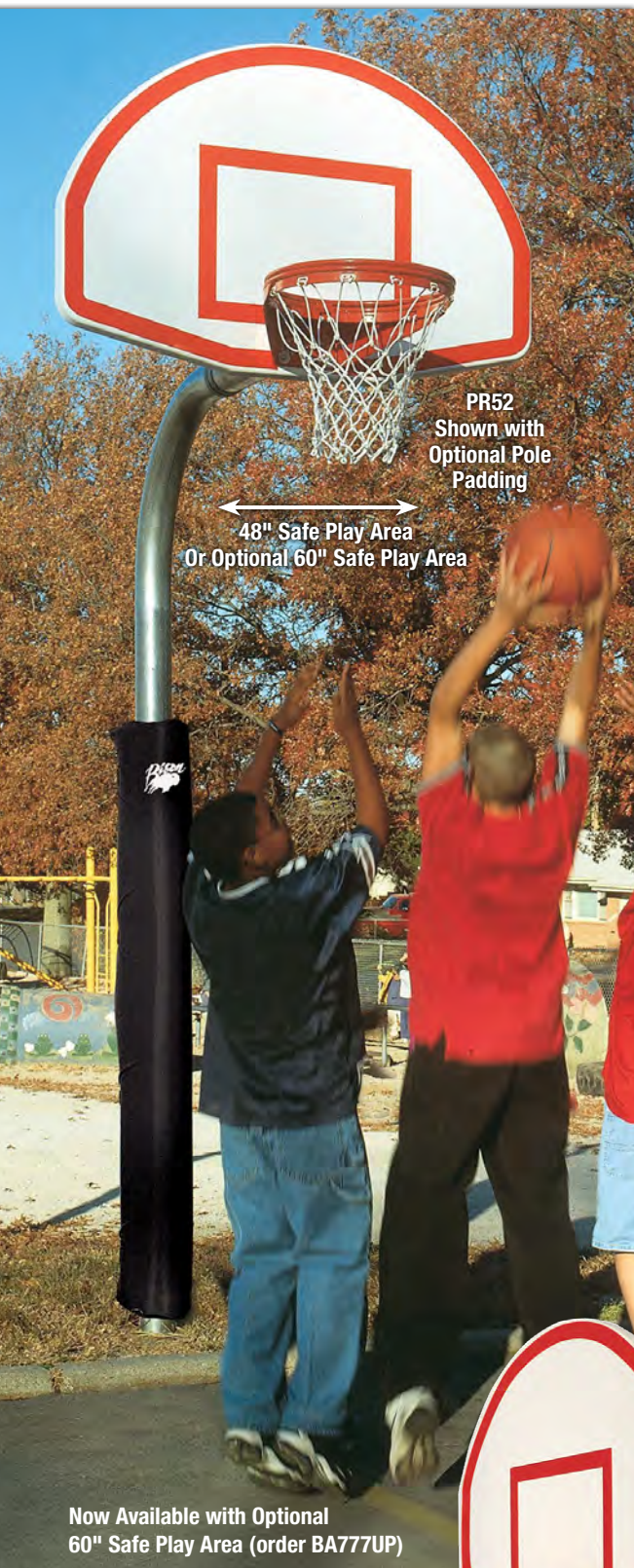

The 4½" O.D. pole on these systems is Bison's Heavy-Duty BA777... Provides 48" safe play area • Direct goal mount design improves backboard durability • Includes heavy-duty 1½" backboard support braces • 48" ground bury for stability even in deep frost regions • Order optional BA777UP to substitute 5' extension pole for standard 4' extension • Galvanized pole and zinc plated hardware • 5" x 5" goal mounting pattern • 25-year limited warranty • Add optional BA700PP pole padding for increased player safety • Order BA777 pole and components separately or in popular packages described below • **25-year limited warranty on pole.**

Order optional BA777UP to increase the safe play area to 60".

PR50 Package on BA777 Pole BA475 Backboard - Unpainted cast aluminum • Fan-shaped 35½" x 54" • Heavy ribbing for maximum rigidity • Rust-free • **Lifetime limited warranty.**

BA39U Goal - Ultimate playground goal • Double, 5/8" steel rim • No-fail netlock adds strength and eliminates netlock breakage • 3/16" thick steel box-style backplate and rim supports • Accepts nylon (included) or chain nets • **Unconditional lifetime replacement warranty.** Approx. PR50 shipping weight: 235#, Truck

PR60 Package on BA777 Pole BA47 Backboard - Ultimate playground backboard • Rectangular 42" x 60" • Safety rolled edges • 12 ga. steel skin • White powder coated finish • Ten-year limited warranty.

BA39U Goal - Ultimate playground goal • Double, 5/8" steel rim • No-fail netlock adds strength and eliminates netlock breakage • 3/16" thick steel box-style backplate and rim supports • Accepts nylon (included) or chain nets • **Unconditional lifetime replacement warranty.** Approx. PR60 shipping weight: 320#, Truck

PR52 Package on BA777 Pole BA475SS Backboard - Rust-free aluminum • Fan-shaped 35½" x 54" • White powder coated finish • Heavy support ribs • Orange shooter's square and border • **Lifetime limited warranty.**

BA39U Goal - Ultimate playground goal • Double, 5/8" steel rim • No-fail netlock adds strength and eliminates netlock breakage • 3/16" thick steel box-style backplate and rim supports • Accepts nylon (included) or chain nets • **Unconditional lifetime replacement warranty.** Approx. PR52 shipping weight: 235#, Truck **No Substitutions.**

PR70 Package on BA777 Pole BA407U Backboard - Bulletproof • Unbreakable clear polycarbonate • Rectangular 42" x 54" • Extruded aluminum framework • White shooter's square and border • **Lifetime limited warranty.**

BA32 Goal - Outdoor flex goal • Designed to withstand playground abuse • One-year limited warranty. Approx. PR70 shipping weight: 300#, Truck

PR55 Package on BA777 Pole BA495 Backboard - Heavy-duty mounting support structure • 12 ga. steel skin • Fan-shaped 39" x 54" • White powder coated finish • Ten-year limited warranty.

BA39U Goal - Ultimate playground goal • Double, 5/8" steel rim • No-fail netlock adds strength and eliminates netlock breakage • 3/16" thick steel box-style backplate and rim supports • Accepts nylon (included) or chain nets • **Unconditional lifetime replacement warranty.** Approx. PR55 shipping weight: 275#, Truck

PR70G Package on BA777 Pole BA407G Backboard - 3/8" thick tempered glass • Rectangular 42" x 54" • Extruded aluminum framework • White shooter's square and border • Five-year limited outdoor warranty.

BA32 Goal - Outdoor flex goal • Designed to withstand playground abuse • One-year limited warranty. Approx. PR70G shipping weight: 330#, Truck

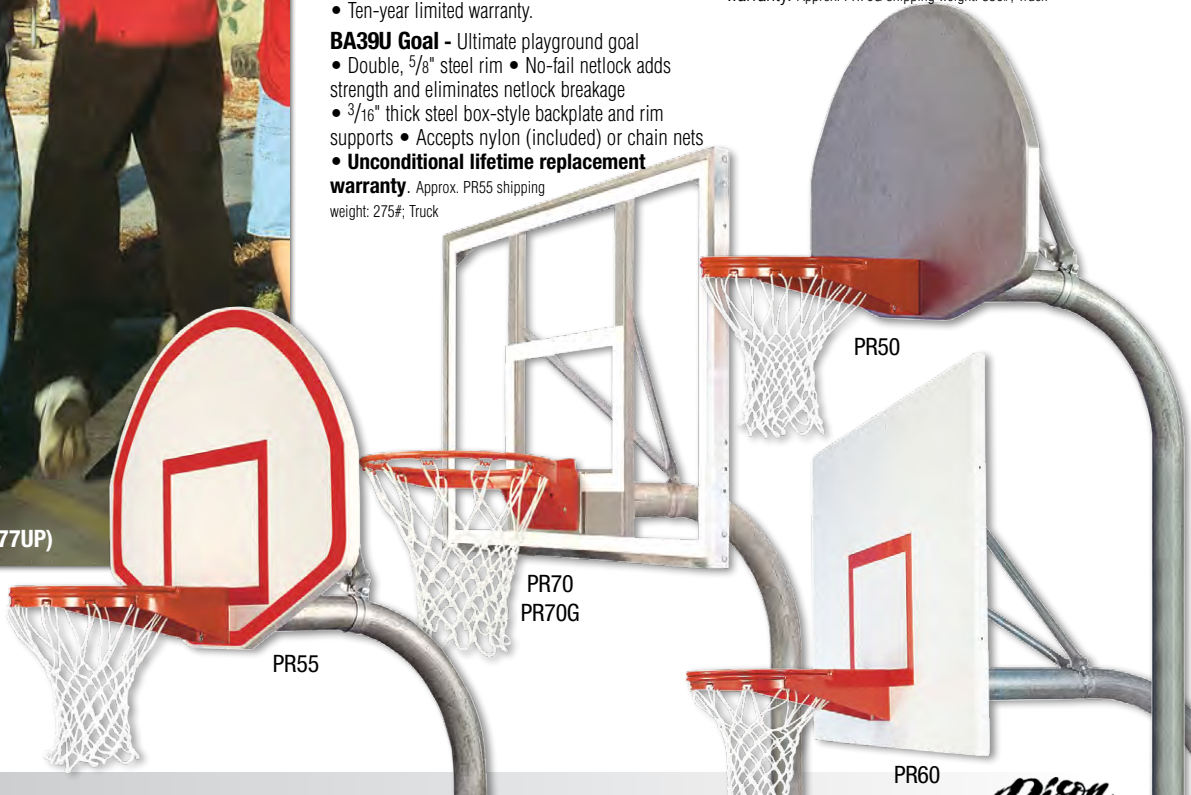

Now Available with Optional 60" Safe Play Area (order BA777UP)



All packages on this page have a 36" safe play area, 36" ground bury and 10-year pole warranty.

Bison's Tough-Duty 3 1/2" O.D. pole... Provides 36" safe play area • 36" ground bury • Direct goal mount design • Heavy-duty 1 5/8" diameter braces to support backboard are included • Galvanized pole and zinc plated hardware • 5" x 5" goal mounting pattern • Add optional BA700PP pole padding for increased player safety • Order BA775 pole and components separately or in complete packages as described below • **10-year limited warranty on pole.**

PR20 Package on BA775 Pole
BA495 Backboard - Heavy-duty mounting support structure • 12 ga. steel skin • Fan-shaped 39" x 54" • White powder coated finish • Ten-year limited warranty.

BA27 Goal - 5/8" steel rim with 1/2" braces and continuous netlocks • One-year limited warranty. Approx. PR20 shipping weight: 215#. Truck

PR29 Package on BA775 Pole
BA475SS Backboard - Durable, rust-free aluminum • Fan-shaped 35 1/2" x 54" • White powder coated finish • Heavy support ribs • Orange shooter's square and border • **Lifetime limited warranty.**

BA27 Goal - 5/8" steel rim with 1/2" braces and continuous netlocks • One-year limited warranty. Approx. PR29 shipping weight: 175#. Truck

No Substitutions.

PR30 Package on BA775 Pole
BA475 Backboard - Unpainted cast aluminum • Fan-shaped 35 1/2" x 54" • Heavy ribbing for maximum rigidity • Rust-free • **Lifetime limited warranty.**

BA27 Goal - 5/8" steel rim with 1/2" braces and continuous netlocks • One-year limited warranty. Approx. PR30 shipping weight: 175#. Truck

PR31 Package on BA775 Pole
BA454 Backboard - 12 ga. carbon steel • Rectangular 39" x 54" • White powder coated finish • Perforated shooter's square • Ten-year limited warranty.

BA27 Goal - 5/8" steel rim with 1/2" braces and continuous netlocks • One-year limited warranty. Approx. PR31 shipping weight: 235#. Truck

PR33 Package on BA775 Pole
BA475 Backboard - Unpainted cast aluminum • Fan-shaped 35 1/2" x 54" • Heavy ribbing for maximum rigidity • Rust-free • **Lifetime limited warranty.**

BA27 Goal - 5/8" steel rim with 1/2" braces and continuous netlocks • *Includes TR95 Court Protector removable goal kit to eliminate unwanted play* • One-year limited warranty. Approx. PR33 shipping weight: 180#. Truck



36" Safe Play Area at 10'

PR31
 Shown with
 Optional BA700PP
 Pole Padding

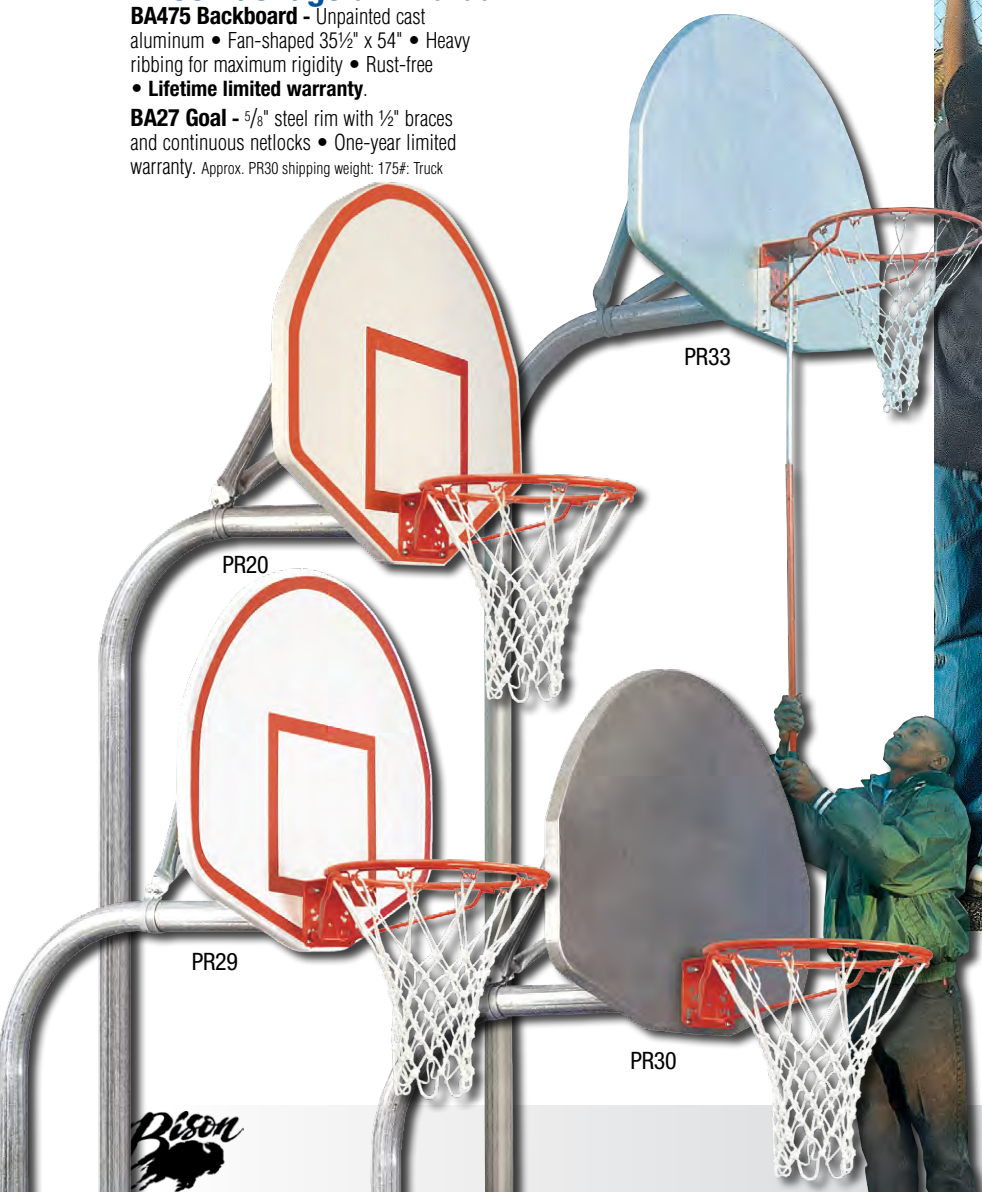



Playground Basketball Packages

Model #	Adjustable	Safe Play Area	Pole Finish	Backboard Material	Backboard Size/Shape	Goal Style	
4" Square Pole See details on page 85.							
PR94U	Yes	36"	Black	Polycarbonate	36" x 54" Rect.	Flex	
5" Square Pole See details on pages 83 - 84.							
PR15	No	36"	Black	Aluminum	39" x 54" Fan	Flex	
PR16	Yes	50"	Black	Aluminum	39" x 54" Fan	Flex	
PR17	No	36"	Black	Steel	42" x 60" Rect.	Flex	
PR95U	Yes	36"	Black	Polycarbonate	36" x 60" Rect.	Flex	
6" Square Pole See details on pages 82 - 84.					*Ask about available 72" Safe Play Area		
BA871	V	No	60"	Black	Steel	42" x 60" Rect.	Double Rim Fixed
BA871XL	V	No	60"	Black	Steel	42" x 72" Rect.	Double Rim Fixed
BA871A	No	60"	Black	Aluminum	42" x 60" Rect.	Double Rim Fixed	
BA871A-GV	No	60"	Galvanized	Aluminum	42" x 60" Rect.	Double Rim Fixed	
BA873	No	60"	Black	Glass	42" x 72" Rect.	Flex	
BA873U	No	60"	Black	Polycarbonate	42" x 72" Rect.	Flex	
PR98U	Yes	50"	Black	Polycarbonate	42" x 72" Rect.	Double Rim Flex	
PR98G	Yes	50"	Black	Glass	42" x 72" Rect.	Double Rim Flex	
PR98S	Yes	50"	Black	Steel	42" x 60" Rect.	Double Rim Flex	
5⁹/₁₆" Round Single Pole See details on pages 86 - 87.							
PR74	No	72"	Galvanized	Polycarbonate	42" x 72" Rect.	Flex	
PR75	V	No	72"	Galvanized	Aluminum	35½" x 54" Fan	Double Rim Fixed
PR75XL	No	96"	Galvanized	Aluminum	35½" x 54" Fan	Double Rim Fixed	
PR76	No	72"	Galvanized	Steel	39" x 54" Fan	Double Rim Fixed	
PR77	No	72"	Galvanized	Steel	42" x 60" Rect.	Double Rim Fixed	
PR77XL	No	96"	Galvanized	Steel	42" x 60" Rect.	Double Rim Fixed	
PR78	No	72"	Galvanized	Polycarbonate	42" x 54" Rect.	Flex	
PR79	No	72"	Galvanized	Perforated Steel	42" x 72" Rect.	Double Rim Fixed	
PR79XL	No	96"	Galvanized	Perforated Steel	42" x 72" Rect.	Double Rim Fixed	
PR87	No	72"	Galvanized	Steel	42" x 72" Rect.	Double Rim Fixed	
PR87XL	No	96"	Galvanized	Steel	42" x 72" Rect.	Double Rim Fixed	
5⁹/₁₆" Round Double Pole See details on page 87.							
PR99	No	72"	Galvanized	Glass	42" x 72" Rect.	Flex	
PR99XL	No	96"	Galvanized	Glass	42" x 72" Rect.	Flex	
4½" Round Single Pole See details on page 88.					*Upgradeable to 60" (order BA777UP)		
PR50	No	48"	Galvanized	Aluminum	35½" x 54" Fan	Double Rim Fixed	
PR52	V	No	48"	Galvanized	Aluminum	35½" x 54" Fan	Double Rim Fixed
PR55	No	48"	Galvanized	Steel	39" x 54" Fan	Double Rim Fixed	
PR60	No	48"	Galvanized	Steel	42" x 60" Rect.	Double Rim Fixed	
PR70	No	48"	Galvanized	Polycarbonate	42" x 54" Rect.	Flex	
PR70G	No	48"	Galvanized	Glass	42" x 54" Rect.	Flex	
3½" Round Single Pole See details on page 89.							
PR20	No	36"	Galvanized	Steel	39" x 54" Fan	Fixed	
PR29	V	No	36"	Galvanized	Aluminum	35½" x 54" Fan	Fixed
PR30	No	36"	Galvanized	Aluminum	35½" x 54" Fan	Fixed	
PR31	No	36"	Galvanized	Steel	39" x 54" Rect.	Fixed	
PR33	No	36"	Galvanized	Aluminum	35½" x 54" Fan	Removable	





BA870PP Shown with Optional ABC52 Lettering and ABC51 Logo BA700PP

Outdoor Safe Stuff™ Pole Padding

Protect players from injury caused by contact with the pole...Bison makes pole padding to fit every pole system we offer • Many styles will also fit other manufacturers' poles, refer to pole description • Velcro® attachment straps • Thick foam covered with all-weather vinyl • One-year limited warranty.

Model	Fits Pole Size/Style	Padding Style	Color	Thickness	Height	Shipping
BA870PP-BK	6" Square Poles, Including Bison's 6" Ultimate Systems	Fitted	Black	1"	74"	Approx. weight: 11#; Sm. Pkg.
BA872PP-BK	All 4 Sides of 6" Square Poles	Fitted	Black	2"	74"	Approx. weight: 14#; Sm. Pkg. Ships Oversize
BA870JRPP	All 5" Square Poles Including PR15 Ultimate Jr. System	Fitted	Black	1"	68"	Approx. weight: 6#; Sm. Pkg.
BA700PP	Any Round or Square Pole to 59/16" Dia.	Wrap-Around	Black	2"	72"	Approx. weight: 11#; Sm. Pkg.
BA79UPP-BK	All 4" Square Poles	Fitted	Black	1"	72"	Approx. weight: 4#; Sm. Pkg.
FBCPP-XX (see page 74)	Any Round or Square Pole to 59/16" Dia.	Fitted	16 School Colors on page 102	5"	72"	Approx. weight: 18#; Sm. Pkg. Ships Oversize

Custom Lettering and Logos for Bison Padding

Show your school spirit with customized padding...Almost any Bison vinyl padding surface can be lettered with up to 10 letters for one low price • All lettering and logos will be sized and spaced by the Bison Art Department based on the size and shape of the padding and the number and style of letters or logo requested • Order multiple ABC51, ABC52, ABC53 for application on multiple sides of padding • Available only on Bison padding.

ABC52 Standard One-Color Lettering

Maximum of 10 letters...Choose from letter styles A, B, C and D • Must select from colors shown on page 102.

ABC53 Second Color Letter Outline Option

Optional addition to letter styles A and B only • Must select from colors shown on page 102.

ABC51 Standard One-Color Logo

Send a logo to Bison Art Department prior to placing order...Artwork subject to pre-approval and hourly BNART artwork charges may apply • Must select from colors shown on page 102 • 12" x 12" maximum size.

ABC52 Letter Styles

A ABC **B ABC** *c ABC* **D ABC**

ABC53 Second Color Letter Outline Example

A ABC53 **B ABC53**

Outdoor Backboard Padding

This molded DuraSkin padding is similar to that used in high schools, colleges and pro arenas across the country, but designed specifically for outdoor durability...Pad provides protection from player contact with front and side of backboard • Fits most rectangular backboards • Bolt-on design requires backboard frame drilling • One-year limited warranty.

Model	Color	Fits Backboard Width	Approx. Shipping Weight
BA48U-BK	Black	48"	6# Sm. Pkg.
BA54U-GR	Gray	54"	6# Sm. Pkg.
BA54U-BK	Black	54"	6# Sm. Pkg.
BA60U-GR	Gray	60"	8# Sm. Pkg.
BA60U-BK	Black	60"	8# Sm. Pkg.
BA72U-BK	Black	72"	8# Sm. Pkg.

TR96 Court Protector™ Removable Goal Package

Complete with goal, bracket, hardware and removal pole to make outdoor basketball systems usable only when desired...

Bison BA27 goal and nylon net can be removed from the specially designed bracket without tools or ladders using the special telescoping pole provided • If desired, goal can be locked in place using padlock (not included) • Package will retrofit to any front mount backboard that uses a 5" x 5" or 5" x 4" goal mounting hole pattern • Use with Bison 3½" and 4½" gooseneck poles only • One-year limited warranty. Approx. shipping weight: 26#; Sm. Pkg.



TR95 Removable Goal Bracket Kit

Eliminate theft and unwanted play...Remove goal from the ground using special pole provided • Goal can also be locked into place (padlock not provided) • Bracket will fit most common front mount playground backboards with 5" x 5" or 5" x 4" goal mounting patterns • Use only with Bison BA27 goals (not included) • Includes bracket, removable pole and mounting hardware • Use with Bison 3½" and 4½" gooseneck poles only • One-year limited warranty.

Approx. shipping weight: 8#; Sm. Pkg.



Gooseneck Pole and Backboard Not Included

TR96





Mix and Match to Create Your Own System!

Choose from 3½", 4½" or 5⅞" O.D. poles...Bent gooseneck or adjustable design • Single or double sided (adjustable only) • Direct goal mount improves backboard durability • Heavy-duty 1⅝" diameter backboard support braces included • All poles are galvanized for a long, rust-free life • Zinc-plated hardware • Deep ground bury depths • 5" x 5" goal mounting pattern • Industry leading warranties.

A 3½" Tough-Duty 3½" O.D. pole...36" safe play area.
10-year Limited Warranty

BA775 Gooseneck Approx. shipping weight: 95#, Truck

BA776 Adjustable Approx. shipping weight: 125#, Truck

BA776DB Double-Sided Adjustable
Approx. shipping weight: 180#, Truck

B 4½" Heavy-Duty 4½" O.D. pole...48" or 60" safe play area.
25-year Limited Warranty

BA777 Gooseneck 48" safe play area. Approx. shipping weight: 150#, Truck

BA777XL Gooseneck 60" safe play area. Approx. shipping weight: 160#, Truck

BA778 Adjustable Approx. shipping weight: 175#, Truck

BA778DB Double-Sided Adjustable
Approx. shipping weight: 240#, Truck

Follow **A B C D** Recommendation To Choose a Backboard Compatible With Your Pole

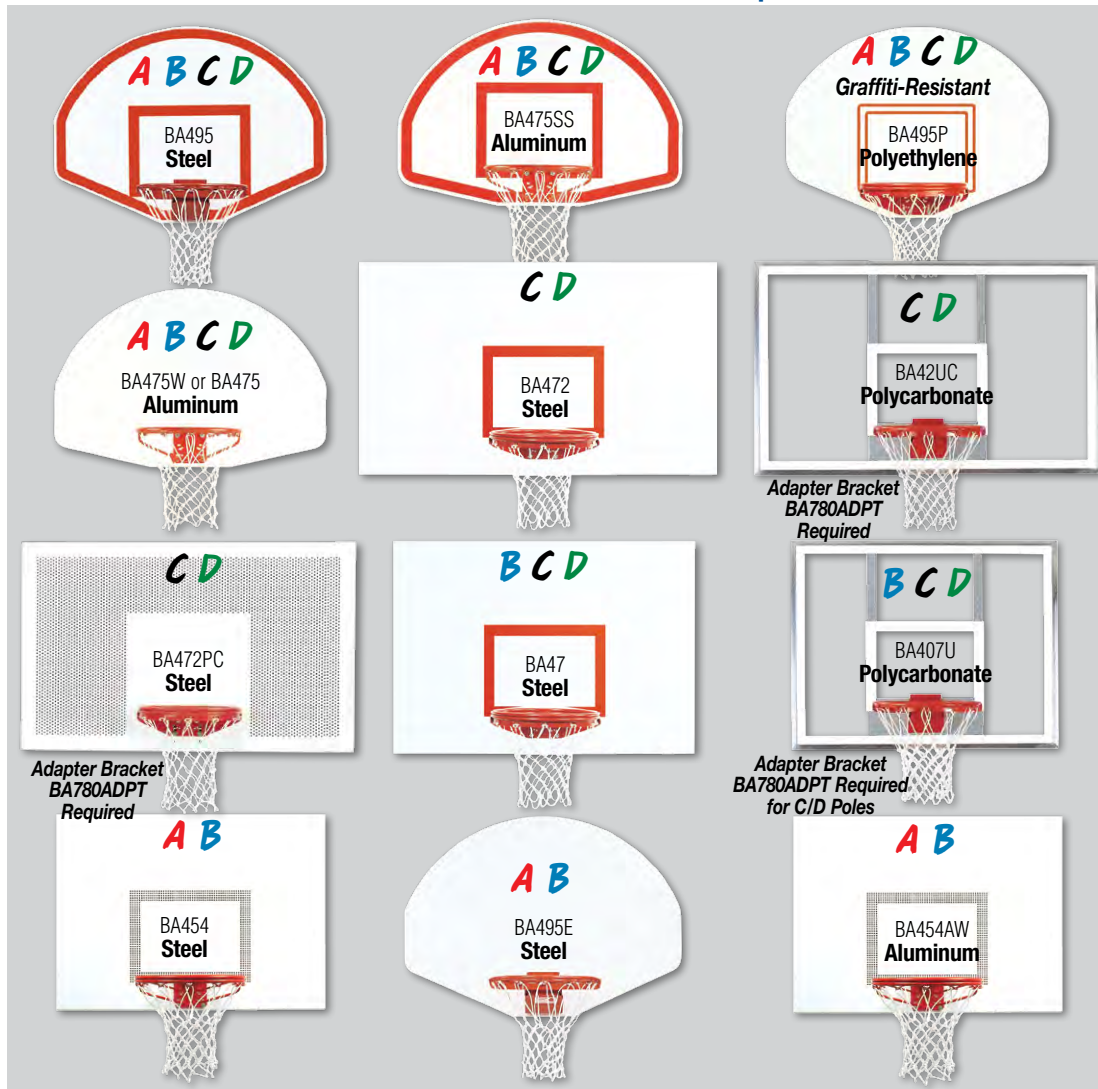
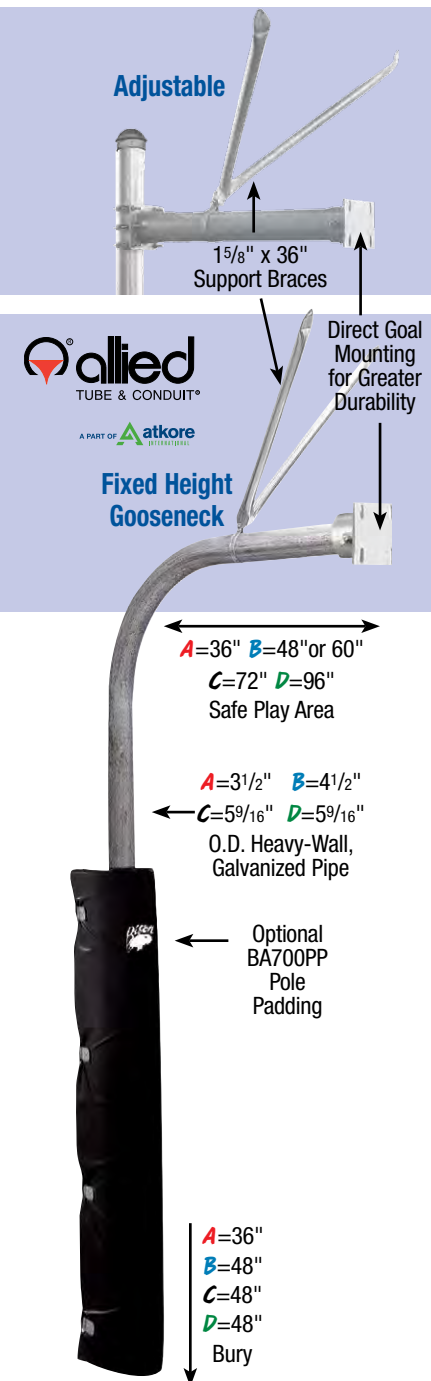

BA776A 3½" Adjustable Arm and Braces Only
Arm is 3½" galvanized steel...Adds 3' extension arm to existing 3½" diameter poles • 1⅝" diameter galvanized braces add backboard support • Existing pole top must be 125" above the playing surface to insure adjustment to 10' goal height • Includes all hardware to mount arm to pole and to backboard • 10-year limited warranty.
Approx. shipping weight: 40#, Sm. Pkg.

BA778A 4½" Adjustable Arm and Braces Only
Add 4' extension to existing 4½" diameter poles that extend at least 125" above playing surface...Includes all mounting hardware and braces • 5" x 5" goal hole pattern • 25-year limited warranty.
Approx. shipping weight: 60#, Sm.Pkg.

BA781A 5⅞" Adjustable Arm and Braces Only
Add 6' extension to existing 5⅞" diameter poles that extend at least 125" above playing surface...Includes all mounting hardware and braces • 5" x 5" goal hole pattern • Lifetime limited warranty.
Approx. shipping weight: 87#, Truck





Bison Makes it Easy to Build to Your Own Specifications

Start with a pole selection and note the letter code... The ABCD letter codes on backboards identify those compatible with your pole

- Choose any goal from the selection below to complete your system
- For more details on these components, check the model number index on pages 106-107, product pages listed provide further information.

C 5⁹/₁₆" Mega-Duty 5⁹/₁₆" O.D. pole... 72" safe play area.
Lifetime Limited Warranty

BA780 **Gooseneck** Approx. shipping weight: 280#; Truck

BA781 **Adjustable** Approx. shipping weight: 320#; Truck

BA781DB **Double-Sided Adjustable**
Approx. shipping weight: 400#; Truck

D 5⁹/₁₆" Mega-Duty XL Extended 5⁹/₁₆" O.D. pole...
96" safe play area. Lifetime Limited Warranty

BA780XL **Gooseneck 8' Extended** Approx. shipping weight: 320#; Truck

Note: To order a BA472 backboard for use on any 5⁹/₁₆" diameter pole substitute BA780-HL to insure proper backboard brace length.

Goals Shown Fit Backboards and Poles on These Two Pages



BA77XBR Backboard Braces Only

These braces will increase the rigidity of other manufacturers' lower-quality gooseneck pole systems... Set of 1⁵/₈" diameter x 36" long, galvanized braces

- Formed and punched ends for easy mounting
- Includes pole mounting bands for 3¹/₂" and 4¹/₂" poles and hardware to mount to pole and backboard.

Approx. shipping weight: 13#; Sm. Pkg.



BA77OSSH Stainless Steel Hardware

Complete kit of stainless steel hardware... Order this kit to substitute stainless steel fasteners on any Bison gooseneck pole system.

Approx. shipping weight: 3#; Sm. Pkg.



Double-Sided Adjustable Shown with Optional FBCPP-BK Pole Padding



A PART OF atkore

INDUSTRIAL

Double-Sided Adjustable Pole Systems

Get more play for the money... Single pole, double fun • Playgrounds, parking lots, tennis courts or any hard surfaced play area can turn into a versatile basketball court with maximum play potential • With a single pole installation, you can provide safe play for two pickup games at once • Available in 3¹/₂" diameter x 36" extension (BA776DB), 4¹/₂" diameter x 48" extension (BA778DB) and 5⁹/₁₆" diameter x 72" extension (BA781DB) • Order backboards, goals and post padding separately • All major components are galvanized for maximum weather resistance • Order FBCPP for 360° pole contact safety.

See shipping weights and warranties above.





BA495

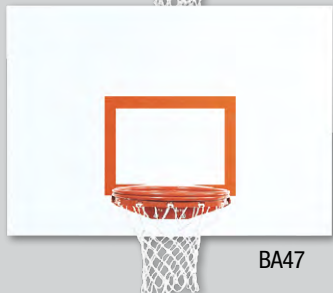

BA47



BA472PC

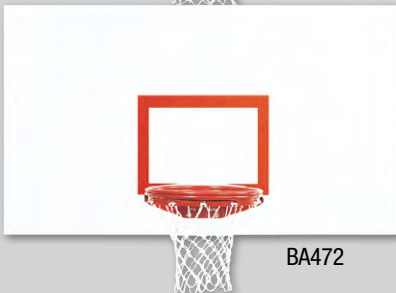

BA472

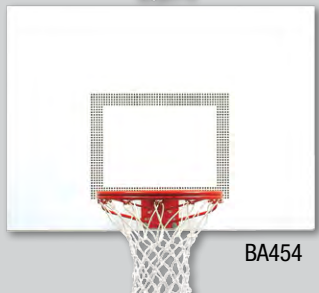

BA454



BA485

BA495 Fan-Shaped Dura Steel™ Backboard

Steel and lots of it highlight this 39" x 54" official size steel backboard...

Superior front mount design • 12 ga. skin • 5" x 5" hole pattern • White powder coated finish • Heavy-duty mounting support structure • Standard 20" x 35" fan-type backboard mounting holes • Heaviest backboard of its type • Official orange border and shooter's square • Ten-year limited warranty.

Approx. shipping weight: 100#; Truck

Note: Order BA495E for economy version of this backboard with a 90-day limited warranty. Similar to BA495 but with lighter rear structure and without orange shooter's square.

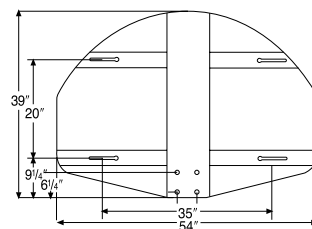

BA47 Ultimate™ Rectangular Steel Backboard

Our most popular rectangular playground backboard... 42" x 60" playing surface • Standard 20" x 35" mounting brackets allow easy attachment to any current fan-shaped ceiling or wall mounting structure • All edges safety rolled to eliminate sharp edges, increase strength and rigidity • Excellent rebound • Regulation orange shooter's square • Durable white powder coated finish • Heavy-duty 12 ga. skin • 7 ga. steel support structure • 5" x 5" goal mounting hole pattern • Designed for Bison Ultimate pole structures, but will also fit most manufacturers' outdoor pole systems • Ten-year limited warranty • Lifetime limited warranty when included on a Bison Ultimate system.

Approx. shipping weight: 145#; Truck

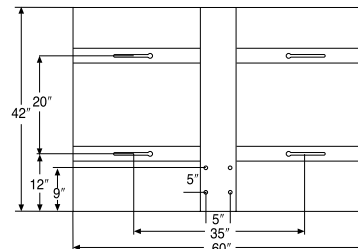

BA472PC Perforated 72" Official Size Steel Backboard

Popular style preferred for use by many inner city playgrounds...

No painted-on shooter's square or border to wear off • Official 42" x 72" size • All edges on the 12 ga. skin are triple bent to eliminate sharp edges and improve rigidity and durability • Heavy tubular frame is mounted to the rear for excellent playability not found on some steel backboards • White powder coated finish • 5" x 4" goal mounting pattern • Check drawing before purchasing to mount on existing pole structures • 10-year limited warranty. Approx. shipping weight: 160#; Truck

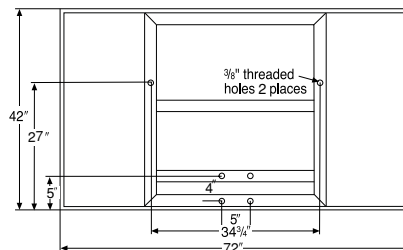

BA472 Ultimate™ Official Size Rectangular Steel Backboard

Our most popular steel backboard is now available in official 42" x 72" size... All edges safety rolled to eliminate sharp edges, increase strength and rigidity • Excellent rebound • Regulation orange shooter's square • Durable white powder coated finish • Heavy-duty 12 ga. skin • 7 ga. steel support structure • 5" x 4" goal mounting hole pattern • Designed for Bison Ultimate pole structures, but will also fit Bison's 5 9/16" gooseneck and most manufacturers' outdoor pole systems • Ten-year limited warranty • Lifetime limited warranty when included on a Bison Ultimate system. Approx. shipping weight: 160#; Truck

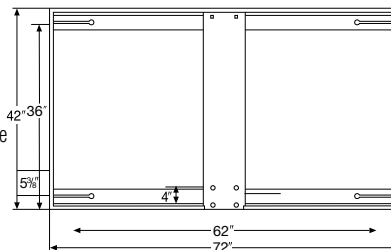

BA454 Perpetual™ Steel Backboard

Perforated shooter's square provides a permanent target that won't deteriorate... 39" x 54" rectangular backboard • 12 ga. carbon steel skin • White powder coated finish • 5" x 5" goal mounting pattern • Ten-year limited warranty. Approx. shipping weight: 110#; Truck

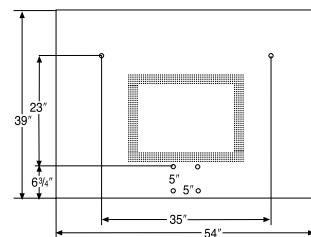

BA485 Ruff Play™ Rear Mount Steel Backboard

Replace your bent and rusty rear mount backboards... Popular rear mount goal design • Same 20" x 35" mounting structure as all rear mount backboards • 12 ga. skin • Universal goal mounting hole pattern • Recommended for replacement use only • New installations should use BA495 front mount board for maximum fan-steel durability • Extra heavy support structure • White powder coated finish • Official 35" x 54" size • Not compatible with any Bison outdoor pole systems • Five-year limited warranty • Ten-year limited warranty if used with BA31U. Approx. shipping weight: 90#; Truck

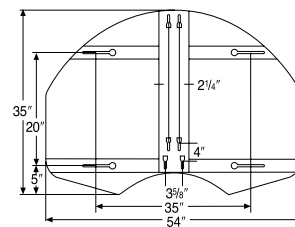

Note: Order BA485E for economy version of this backboard with a 90-day limited warranty.

Order Goals Separately

WARNING!

All backboard warranties are invalid when not mounted properly on pole systems or structure with direct rim mount supports.



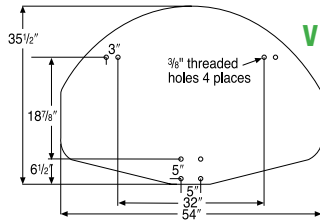

BA475SS Lifeguard™ White Aluminum Backboard With Shooter's Square

Official shooter's square and orange border on cast aluminum...Same durable, rust-free backboard as BA475 • White powder coated finish • 5" x 5" goal mounting hole pattern • 35 1/2" x 54" • Heavy support ribs • Requires direct mount pole system • **Lifetime limited warranty.** Approx. shipping weight: 55#; Truck

See Page 19 for BA465 Fiberglass Fan Backboard

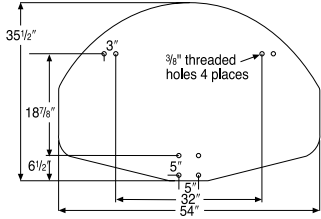

BA475W Lifeguard™ White Aluminum Backboard

Cast aluminum with white powder coated finish...Same backboard as BA475SS above except solid white, no orange graphics • **Lifetime limited warranty.**

Approx. shipping weight: 55#; Truck

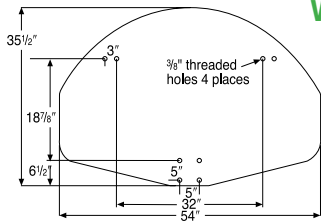

BA475 Lifeguard™ Cast Aluminum Backboard

Unpainted cast aluminum backboard for a lifetime of use without deterioration...35 1/2" x 54" • No rust, even in the wettest climates • Heavy ribbing for maximum rigidity • 5" x 5" goal mounting hole pattern • Requires direct mount pole system • "As Cast" finish will vary • **Lifetime limited warranty.**

Approx. shipping weight: 55#; Truck

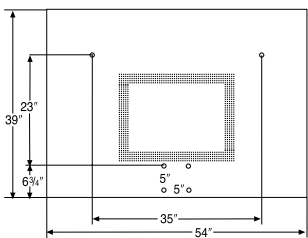

BA454AW Perpetual™ White Aluminum Backboard

Perforated shooter's square provides a visible target without the deterioration of screened shooter's squares...39" x 54" rectangular backboard with 1/8" thick aluminum skin • White powder coated finish • 5" x 5" goal mounting pattern

• **Unconditional lifetime warranty.** Approx. shipping weight: 55#; Truck

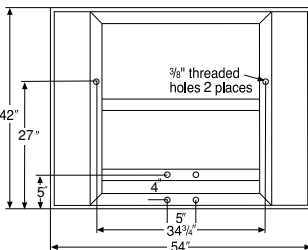

BA407U Unbreakable Polycarbonate Backboard

This backboard repels vandalism...Clear, 1/2" thick polycarbonate material is virtually bulletproof • Top quality appearance for outdoor systems • Extruded aluminum framework is identical to that used on our premium competition glass backboards • Powder coated steel structure absorbs stress of player contact with the goal • 42" x 54" with white shooter's square and border • **Lifetime limited warranty.** Approx. shipping weight: 130#; Truck

See Page 19 for BA407G Glass 42" x 54" Backboard

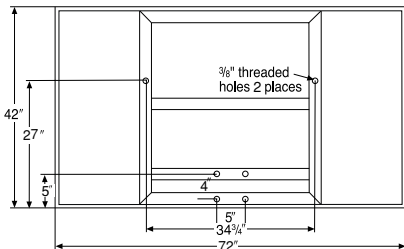

BA42UC Unbreakable 72" Official Size Polycarbonate Backboard

Clear, full sized yet bulletproof...72" x 42" clear polycarbonate is a full 1/2" thick and supported by a heavy-duty aluminum frame and steel rear support structure

• Looks exactly like a competition glass backboard with white shooter's square and border • Steel components have a durable powder coated finish • 5" x 4" goal mounting pattern • Check drawing before purchasing to mount on existing pole structures • **Lifetime limited warranty.** Approx. shipping weight: 230#; Truck

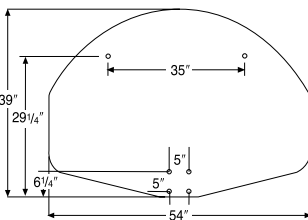

BA495P Rust-Free Polyethylene Fan-Shaped Backboard

Never worry about rusty backboards again...39" x 54" x 1" thick polyethylene back-board • Impervious to coastal salt spray • Bright white front and back molded around orange core • Shooter's square has been machined into face to provide a permanent target not available on other poly backboards • 5" x 5" goal mounting hole pattern • Requires direct mount pole system • **Lifetime limited warranty.**

Approx. shipping weight: 65#; Truck



BA475SS



BA475W



BA475



BA454AW



BA407U



BA42UC



BA495P

WARNING!
All backboard warranties are invalid when not mounted properly on pole systems or structure with direct rim mount supports.

Order Goals Separately



v BA39U **Ultimate™** Front Mount Playground Goal

The first and still the **ONLY** unconditional lifetime replacement warranty on a basketball goal!



The Ultimate goal for tough playgrounds...
 Double, 5/8", solid rim design • 3/16" x 1" no-fail netlock adds to strength of goal and eliminates netlock breakage • 3/16" thick "box" design backplate and rim supports • Traditional orange BA39U has a durable, baked powder coated finish • **Order BA39U-GV for a hot dip galvanized Coastal Ultimate goal** • Includes high tensile strength mounting hardware and premium nylon net • **Unconditional lifetime replacement warranty.**

Approx. shipping weight: 27# each; Sm. Pkg.

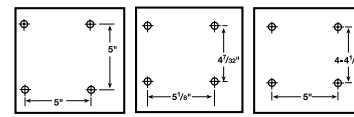

BA39U fits backboards with any of these hole patterns.



BA33U Double-Rim, Heavy-Duty Flex Goal

The industry's first double-rim flex goal...Low maintenance design can be used indoors or outdoors • 5/8" solid steel rings supported by 3/16" x 1 1/2" rim support • 15° of deflection, auto return • **Universal backplate** • No-fail netlock system for chain, nylon or web nets • The best of breakaway and double-rim goal designs • Includes mounting hardware and nylon net • One-year limited warranty. Approx. shipping weight: 29# each; Sm. Pkg.

BA32 Heavy-Duty Side Court and Recreational Flex Goal

The only affordable flex goal built to take the abuse of playground, gym or home use...Simple, low-maintenance design can be used indoors or outdoors • 5/8" steel rim supported by 3/16" x 1 1/2" support • 15° deflection, auto return • Durable, orange, baked powder coated finish • Not approved for interscholastic high school or collegiate play • **Universal backplate** • Includes mounting hardware and nylon net • One-year limited warranty. Approx. shipping weight: 22# each; Sm. Pkg.

BA37N Front Mount Double-Rim Goal with No-Tie Netlocks

Super strong, super goal...Double 5/8" steel ring for extra durability • Twelve no-tie netlocks to accept nylon net • 3/16" thick **universal backplate** • Packaged two goals per carton • Includes mounting hardware and nylon net • One-year limited warranty. Approx. shipping weight: 18# each; Sm. Pkg.

BA37 Front Mount Double-Rim Goal

Double rim for durability, two rim support braces for added strength...3/16" steel **universal backplate** fits all front mount boards • Bottom ring is 1/2" diameter and formed to accept either BA53 chain net (included) or BA50 premium steel net (optional) • Packaged two goals per carton • Includes mounting hardware • One-year limited warranty. Approx. shipping weight: 18# each; Sm. Pkg.

BA28 Magnum™ Heavy-Duty Playground Goal

Maximum strength for Magnum force...Goal has extra thick 3/4" diameter ring, 5/16" thick universal backplate and 5/8" rim support • Continuous netlocks • Fits all front mount backboards • Ideal for courts where conditions call for maximum strength but a double rim is not desired • Packaged two goals per carton • Does not meet NCAA or high school standards for competition • Includes mounting hardware and nylon net • Two-year limited warranty. Approx. shipping weight: 21# each; Sm. Pkg.

BA27A Front Mount Super Goal

Excellent upgrade from standard front mount goals at lower cost than double rim or breakaway goals...Full 5/8" computer designed reinforcing bar gives "super support" when player suspends from goal • Additional 5/8" brace at the vulnerable joint between rim and backplate • Continuous netlocks • 1/4" thick steel **universal backplate** • Durable, baked powder coated finish • Packaged two goals per carton • Includes mounting hardware and nylon net • Two-year limited warranty. Approx. shipping weight: 17# each; Sm. Pkg.

BA27 Standard Front Mount Competition Goal

Universal backplate of 3/16" steel for mounting to virtually all boards, institutional and home...1/2" reinforcing bar, computer engineered for maximum support • Continuous netlocks • High-penetration continuous welded joints • Durable, powder coated finish • Packaged two goals per carton • Includes mounting hardware and nylon net • One-year limited warranty. Approx. shipping weight: 13# each; Sm. Pkg.





BA31U **Ultimate™** Rear Mount Playground Goal

The only rear mount goal with an unconditional lifetime replacement warranty!

Double $\frac{5}{8}$ " High Tensile Steel Rim

Includes Rear Mount Backboard Protector Angle

Durable, Powder Coated Finish

Heavy Steel Rim Support

Continuous, No-Fail Netlock System

Optional BA50 Premium Chain Net

Unconditional Lifetime Replacement Warranty

Universal hole pattern fits all rear mount backboards.

Rear Mount goals are recommended for replacement only. Rear mount goals are not compatible with any Bison pole systems.

Same high-strength, double $\frac{5}{8}$ " solid rim design as BA39U front mount goal...No-fail netlocks

- Will accept chain, nylon or web nets
- Universal rear mount hole pattern
- Includes unique backboard protector angle to protect vulnerable rear mount backboards
- To use this option, drill holes through the backboard and pass bolts provided completely through the goal and backboard to double the backboard strength (see inset)
- Protector angle will not interfere with play
- Packaged individually
- Includes mounting hardware and nylon net
- Shown with optional BA50 premium chain net
- **Unconditional lifetime replacement warranty.** Approx. shipping weight: 34# each; Sm. Pkg.

BA32RXT **FlexCourt™** Rear Mount Flex Goal

Ideal for outdoor playgrounds or indoor courts with rear mount fan-shaped steel backboards...Same heavy-duty design as Bison BA32 front mount flex goal

- Double steel die spring action
- Built to absorb stress from aggressive action around the rim
- Helps protect vulnerable steel backboards from damage
- **Universal backplate** mounts to all rear mount backboards
- Official $\frac{5}{8}$ " diameter ring
- Heavy $\frac{3}{16}$ " thick rim support
- Includes mounting hardware and nylon net
- One-year limited warranty. Approx. shipping weight: 20# each; Sm. Pkg.

BA31N Rear Mount Double-Rim Goal with No-Tie Netlocks

Double $\frac{5}{8}$ " rim for extra durability in unsupervised applications...Universal backplate mounts to all rear mount backboards

- Baked powder coated finish
- Packaged two goals per carton
- Includes mounting hardware and nylon net
- One-year limited warranty.

Approx. shipping weight: 28# each; Sm. Pkg.

BA21A Rear Mount Super Goal

Stronger than other manufacturers' standard rear mount goals... $\frac{1}{4}$ " continuous welded support ring for over half of the rim circumference

- Continuous netlocks
- Additional bracing at the backplate joint gives greater strength when player suspends from goal
- $\frac{3}{16}$ " **Universal backplate** mounts to all rear mount backboards
- Durable powder coated finish
- Packaged two goals per carton
- Includes mounting hardware and nylon net
- Two-year limited warranty.

Approx. shipping weight: 20# each; Sm. Pkg.

BA21 Standard Rear Mount Competition Goal

Replace bent and broken goals on any brand of rear mount backboard...Heavy-duty $\frac{3}{16}$ " welded backplate assembly

- $\frac{3}{16}$ " support ring for over $\frac{1}{2}$ of the rim circumference
- Continuous netlocks
- **Universal backplate** mounts to all rear mount backboards
- Durable powder coated finish
- Packaged two goals per carton
- Includes mounting hardware and nylon net.
- One-year limited warranty. Approx. shipping weight: 20# each; Sm. Pkg.

Rear mount goals are recommended for replacement only. Rear mount goals are not compatible with any Bison pole systems.

BA32RXT

BA31N

BA21A

BA21

Universal hole pattern fits all rear mount backboards.

4"

$\frac{4}{16}$ "

$\frac{2}{16}$ "

$\frac{3}{16}$ "

$\frac{3}{16}$ "

$\frac{3}{16}$ "



CM200 Three-Point Reusable Steel Court Stencil

No more flimsy paper or plastic stencils that tear or blow in the wind... Easy-to-use stencil kit marks court after court with sharp straight lines • Minor cleaning of paint build up will allow stencils to last virtually forever • Kit includes 20 ga. steel stencils to paint 1½" wide base line, lane, free-throw line, top of key and official high school three-point line • Requires 2 to 3 cans of Bison CM111 Court Marking Spray Paint or similar product for each complete court • Stencil kit is ideal for park departments, school district maintenance departments, playground installation crews or anyone wanting a quality outdoor basketball court. Approx. shipping weight: 55#, Sm. Pkg.



CM111 Court Marker Paint

Specially formulated, white spray paint is designed to last... Easy-spray nozzle • 18 oz. can • Requires 2 to 3 cans per complete court • Order CM111CS for 12 can case quantity. Approx. shipping weight: 1#, Sm. Pkg. No Air Shipments

CM100 Court Marking Kit

Single use stencil kit makes marking the free throw lane and three-point line easy... Improves the value of driveway practice for players who play competitively • Kit includes 2 cans of CM111 high quality, specially formulated court marker paint • Order CM100S for Court Marking Stencil without paint. Approx. shipping weight: 8#, Sm. Pkg. No Air Shipments



BA50



BA53

BA50 Premium Steel Playground Safety Net

This chain net will virtually eliminate the risk of loose and dangling chain links found on other chain nets... All links are welded into closed loops to eliminate separation caused when chains are stretched during play • Extra heavy-duty "S" hooks are used for attachment to any style or make of goal • Zinc plated and three times heavier than normal chain nets • Two-year limited warranty. Approx. shipping weight: 3#, Sm. Pkg.

BA53 Standard Chain Net

Heavier than most other manufacturer's chain playground nets... Outperforms common nylon nets • The heavy-duty "S" hooks attach to any style of goal • This is the standard net provided with Bison BA37 goal • Zinc plating provides protection from the weather. Approx. shipping weight: 2#, Sm. Pkg.

BA51H Anti-Whip Net

Competition grade, affordable price... Heavy braided nylon to reduce net whip common with lighter weight nets • Bright white • Use for competition or as upgrade to normal residential or playground string nets. Approx. shipping weight: 1#, Sm. Pkg.

BA501H Standard Competition Net (not shown)

Heavier than nets generally supplied with goals... Braided nylon • Bright white • Excellent value. Approx. shipping weight: 2#, Sm. Pkg.

BA52H Economy Basketball Net (not shown)

Weather-resistant nylon net will fit on any style goal... Our most affordable net. Approx. shipping weight: 1#, Sm. Pkg.

BA56W Weld-On Repair Netlocks

A must for every park and recreation maintenance department... Low cost standard netlocks can be welded on in the shop • 12 per package. Approx. shipping weight: 1#, Sm. Pkg.

BA10 Replacement Shooter's Square

Ready-to-apply, official size, vinyl shooter's square will renew the look of your painted steel, wood or fiberglass backboards... Applies easily without messy adhesive or paint • Makes backboards good as new • Same heavy-duty, self-adhesive vinyl used for exterior automotive detailing • Installs in five minutes • Instructions and applicator included. Approx. shipping weight: 1#, Sm. Pkg.



BA51H



BA56W



BA10





Bison dealers and their customers now have access to the full product line of Bison's site furnishings division, BRP, through Bison's extensive national dealer network.

Benches, recycling and litter receptacles and bike racks are common needs of indoor and outdoor sports facilities. Bison customers can count on the same great quality and customer service on BRP site furnishings that they have come to expect from Bison's sports equipment.

Call for a full catalog and pricing or visit BRPbybison.com to see our complete line.

Bike Racks

BRP bike racks come in a wide variety of styles and finishes, some in-stock for immediate delivery... Wave and Flip Up bike racks are constructed of 2 3/8" OD heavy wall pipe and finished in a wide variety of powder coated or hot dip galvanized finishes • Bike capacities range from 2 to 13.



BWA2-07-SM



BFU2-02-SM

Benches

BRP benches are built to last... The all steel construction and two-layer powder coated finishes provide years of durable, aesthetically pleasing and safe use in all types of climates • Choose from standard designs or customize benches with laser cut logos, facility names or donor recognition plaques.



PC101-72



MC101-72

Receptacles

BRP receptacles are the perfect complement to our benches and are available in multiple styles for recycling or litter collection...

Custom logoed or lettered receptacles add a touch of class to otherwise unattractive litter collection efforts at sport fields, parks and in pedestrian areas • Litter receptacles are available in a wide range of colors • Recycling receptacles are powder coated industry common ecoblue.

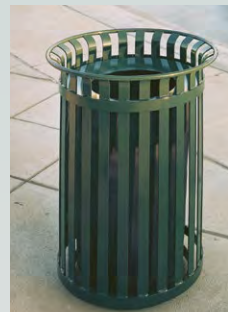

MC402-FT



ES101-72



PC401-FT



PC450-FT



MC450-FT



MC106-72





How to Select a Basketball System for Your Home

Choosing between a fixed height and an adjustable pole system...Make this decision based upon the ages of the players and the level of basketball you want to play. The official high school and college competition goal height is 10', but a new basketball system fixed at 10' will be a big disappointment to youngsters learning to get the ball to the goal. Most young players and teens will also want to lower the goal below 10' for slam dunk action. A 10' fixed-height goal is appropriate if you want to play only at the official competitive height.

The backboard material affects the quality of play...Glass is used for all competition backboards in high school, college and pro arenas because a glass backboard gives the best ball rebound. A home court with a Bison TruGlass backboard is the best training ground for competitive-level skills. Clear acrylic backboards, which give the look of glass, and backboards of graphite or fiberglass all have aesthetic, durability or price benefits – but none of these compare to the playability of glass.

Look for durability to ensure years of family fun...Beware of basketball equipment makers that litter neighborhoods with rusty, tilting poles, backboards that age too soon and sagging goals. Compare features to get a clear picture of what you can expect your system to look like in the years ahead. Bison's warranties will give you confidence that your equipment will stand up to years of use.

Safety is not an option. Generous setbacks and pole padding are essential...The distance between the pole and the backboard ranges from 22" to 60" on Bison pole systems. There's no one blowing a whistle under the boards in most driveway games. If you expect aggressive play, you should consider a greater safe play area. Pole and backboard padding also add a measure of safety when there is rough-housing on your court. In the interest of your kids' safety, Bison makes SafeStuff pole padding standard on every residential system.



Consider where the system will be installed...Will your system be installed on a driveway in the front of the house? On the side, or out of sight in the back yard? Street appeal and coordination with your home and landscape should influence your purchasing decision in more visible areas. Choose a system that complements not overwhelms your home and landscape.

Plan for your family's future...Select a system that will keep up with changing skill levels. If you want your youngsters to play with you now and on a competitive team in the future, you should carefully consider pole and backboard rigidity. Always select equipment warranted to stand up to active play. And look for equipment that won't detract from the value of your landscape.



All Conference BA89QC-AW with 48" backboard

4" QwikChange™ Adjustable Basketball System

Hard work and dedication pay off on the court and in the design and manufacture of quality equipment as well...Bison's 4" square QwikChange poles have 75% more steel than common round poles • One of these systems is going to look great in your driveway for years to come! • It's going to grow with your kids, too. Height adjusts from 7½' to 10' in 6" increments. • The height adjustment mechanism has over ten times the pivot contact area of commonly compared round pole systems, so go ahead and let them slam dunk! • The mounting design for the pro-style flexible goal transfers playing stress to the pole, protecting the backboard.

Approx. shipping weight: 150#; Truck

- Clear Acrylic Backboard
- 22" Safe Play Area at 10'
- Aluminum Backboard Frame
- QwikChange Height Adjustment
- Fast Break Flex Goal
- Backboard Protecting Direct Goal Mounting
- Four Backboard Braces for Added Support
- Textured Black Powder Coated Pole Finish
- Approx. 30" Deep Bury
- **FREE** Fitted Pole Padding



Easy Height Adjustment

"No matter where I find myself coaching, playing or watching basketball, I expect quality equipment. For my backyard court, I chose Bison so no matter what the level of play, I know the game is authentic. I especially value the fact that every Bison residential system comes standard with SafeStuff pole safety padding."



Bill Self,
Head Men's Basketball Coach
University of Kansas Jayhawks





Understand What You are Buying

Understanding what you're buying is key to getting the right basketball system for your home. Bison uses the following terms to help point out key features and differences on our systems.

Safe Play Area...As the name implies, the greater the safe play area the greater the player safety during aggressive play. Safe play area is the distance from the face of the backboard to the pole. On a competition indoor court the distance from the face of the backboard to the out-of-bounds line is 48". Safe play area is particularly important on systems that are regularly lowered for slam dunk action.

SafeStuff™...Only Bison includes a pole pad with every residential system. We call this feature SafeStuff because we don't think player safety should be optional.



DuraSkin®...In the late 1980's Bison developed a dense molded bolt-on backboard padding system that was durable for indoor or outdoor use. Often imitated, but never equalled, DuraSkin is available as an option on any rectangular backboard. Backboard padding is required at all levels of official college and high school play to protect players from backboard contact.

Direct Goal Mounting...Backboard durability is virtually a non-issue on a Bison system due to the goal mounting system that effectively mounts the goal through the backboard and directly into the steel pole structure. There is almost no stress put on the backboard even during slam dunk action.

Flex Goal...Bison flex goals are designed with many of the same durability features of our competition breakaway goals but require less pressure to release. This improves player safety and rim life. Flex goals will hold up in any climate.

Direct Bury...This method of installing a pole system inserts the pole into the ground between 30" and 48" depending upon the size of the system. Concrete is placed around and in the bottom of the pole making the installation permanent. Ground sleeves are available for 4" direct bury poles to make removal possible.

Pedestal Base Mounting...Many Bison systems have a mounting plate on the bottom of the pole that allows them to be bolted onto (and unbolted from) a poured foundation with protruding threaded bolts. This lets you easily take your investment with you when you move.

Powder Coated Finish...Powder coating provides a finish that is far superior to a finish from a wet spray paint system. In addition to beauty and durability, powder coating is environmentally and employee friendly, without the hazardous waste and toxic fumes common with the wet paint process.

TruGlass™...Bison pioneered the use of actual tempered glass on residential basketball systems over 25 years ago. Over the years an ever increasing number of homeowners have recognized the superior rebound of TruGlass. Today Bison sells only TruGlass on most systems.

Acrylic Backboard...While tempered glass is the norm in virtually every gymnasium in the country, home backboards have traditionally been constructed of clear acrylic, a plastic material, due to cost and other considerations. Acrylic provides the look but not the rebound of tempered glass.

See pages 84 for 6" Pole Systems with official 72" wide glass backboards.



4" & 5" QwikLift™ Adjustable Basketball Systems

No major manufacturer has a longer history of building crank adjustable residential basketball systems with tempered glass backboards than Bison...And no one else takes player safety so seriously that FREE Safe Stuff pole padding is included on every residential system • QwikLift is our newest offering and includes such popular premium features as a removable pedestal base, tempered clear TruGlass backboard, full 36" safe play area at 10' goal height and extended 42" at 8', easy-to-operate rear goal height adjustment crank, competition grade breakaway goal, free pole safety padding and limited lifetime warranties on backboard and pole system (one-year on rim, crank and padding) • Choose an Atlantis 4" pole with 54" backboard or an Olympus 5" pole with 60" backboard. Either way, you'll be a hero to your kids when you put one of Bison's premium QwikLift basketball systems in your driveway. Approx. shipping weight: 310# (4"), 350# (5"); Truck



- Clear TruGlass Tempered Glass Backboard
- Gymnasium Quality Heavy-Duty Competition Flex Goal
- Backboard Protecting Direct Goal Mounting
- Textured Black Powder Coated Pole Finish
- QwikLift Rear Crank Height Adjustment
- Choose 4" or 5" Pole
- 36" Safe Play Area at 10'
- Aluminum Backboard Frame
- Goal Height Indicator
- Infinitely Adjustable from 7½' to 10'
- **FREE** Fitted Pole Padding
- Removable Pedestal Base
- Optional Backboard Padding



Infinite Goal Height Adjustment



Easy To Read Goal Height Indicator

BA8250X
Atlantis
4" pole with 54" backboard (shown)

BA9250X
Olympus
5" pole with 60" backboard

4" & 5" ZipCrank™ Adjustable Basketball Systems

You'll see and feel the difference between Bison ZipCrank systems and other manufacturers' systems...Bison uses our experience as a manufacturer of competition grade equipment to offer TruGlass tempered glass backboards that give players a more realistic rebound • Every backboard has an aluminum frame just like those in the gym • The extra heavy poles and front crank style height adjustment are designed to change the height of the breakaway goal from 7½' to 10' with the turn of the removable crank handle • As an added bonus, Bison ZipCrank systems can be mounted closer to fences, walls or other obstacles than rear height adjustment systems • All systems include free fitted pole padding • Limited lifetime warranties on backboard and pole system (one-year on rim, crank and padding). Approx. shipping weight: 250# (4"), 325# (5"); Truck

- Clear TruGlass Tempered Glass Backboard
- Choose 4" or 5" Direct Bury Pole
- Gymnasium Quality Heavy-Duty Competition Flex Goal
- Backboard Protecting Direct Goal Mounting
- Textured Black Powder Coated Pole Finish
- 30" Safe Play Area
- Aluminum Backboard Frame
- ZipCrank Front Crank Height Adjustment
- Removable Hand Crank Prevents Unwanted Adjustment
- Goal Height Indicator
- **FREE** Fitted Pole Padding
- Optional Backboard Padding

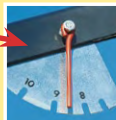

BA8350
Lottery Pick
4" pole with 54" backboard

BA9350
Four Seasons
5" pole with 60" backboard (shown)



Full Color Graphic Printing Options

While it is theoretically possible to print any color with our 4-color Sport Pride graphic printing process, refer to the chart on the right as a basic guide to color selection. Our graphic designers will work with you for a final color and design selection. Sport Pride graphic printing is available on gym and outdoor wall padding, scoring tables and some additional padding and banner products. Inquire about custom color availability.

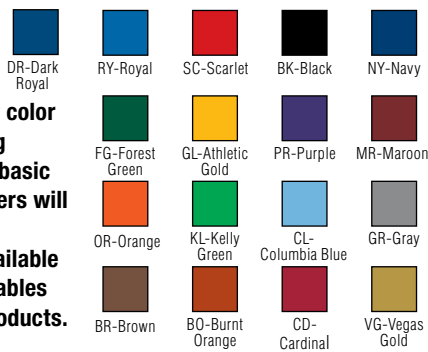

Solid Color Vinyl Padding Options

Single solid color, vinyl padding can be selected from the colors at right. Product examples include: volleyball post and base padding, football post padding, T-Rex and other portable basketball padding, solid color wall or outdoor padding, team stools, solid color scoring table padding; lettered wall, outdoor or scoring table padding background color.

Note: Pink is only available on wall padding and volleyball post padding.

Note: Dark Royal is only available on wall padding, volleyball post padding and football post padding.



Printing Colors on Padding with 1- or 2-Color Lettering or Logos

Add any one or two colors shown at right to print on solid color vinyl padding. See ABC50, ABC51, ABC52 and ABC53 for printing options.

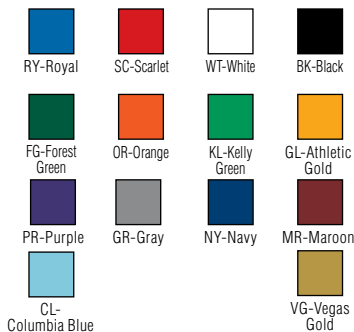

Ready to Apply (RTA) Adhesive Vinyl Lettering Colors

Select from vinyl colors on right to add custom lettering to ball carts, equipment carts and other powder coated steel sports equipment surfaces. See ABC92 for details.



See page 58 for ABC54 logo labels.



Color Options for Aluminum Bench and Bleacher Seats

4', 7½' and 15' length aluminum seats and backs can be finished in any of the colors shown at right.

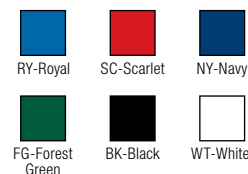

Competition Backboards

Details on Pages 18 and 19

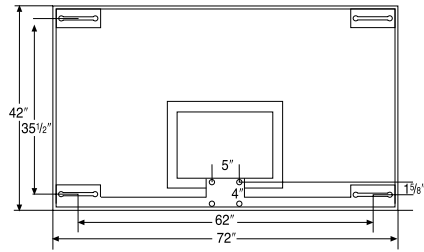

BA42XL

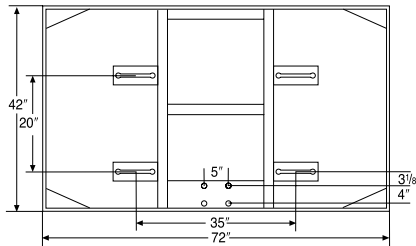

BA42XLC

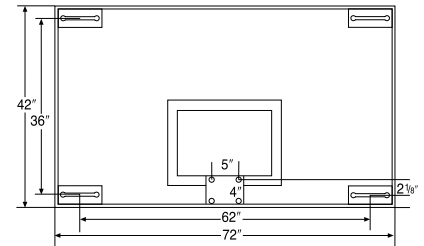

BA42E

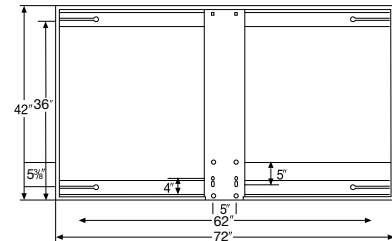

BA472

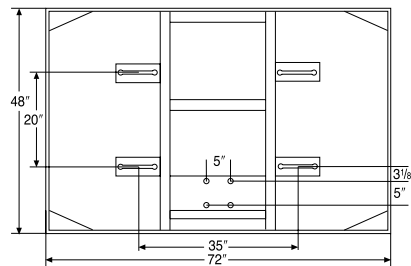

BA48XLC

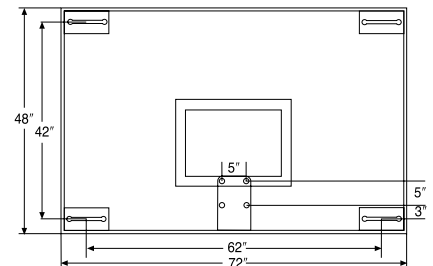

BA48

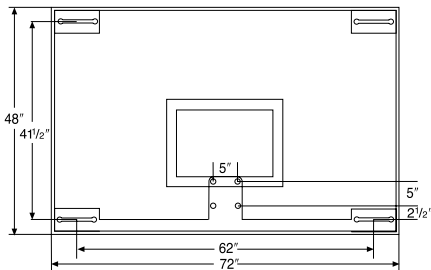

BA48XL

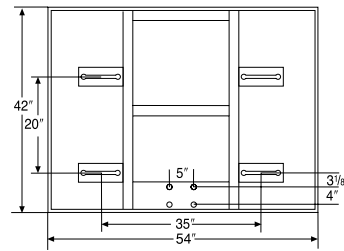

BA407C

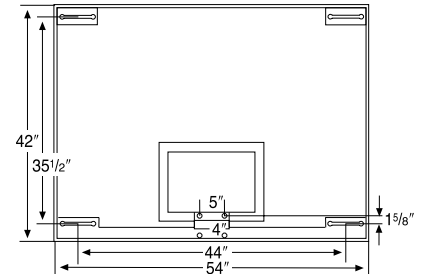

BA407G

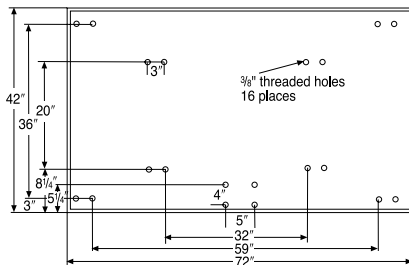

BA455

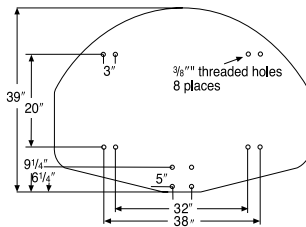

BA465

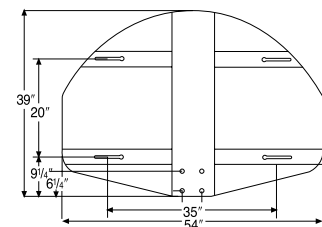

BA495

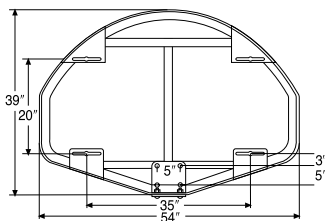

BA44XL

A picture is worth a thousand words... send us yours! E-mail photos or videos to photoeng@bisoninc.com for expert installation assistance, help with warranty issues, product suggestions, and general questions. Large files should be sent via sendspace.com or request Skype information for real-time problem solving.



Goal Mounting Patterns

Bison Universal Backplate Fits All A through H Hole Patterns on Front Mount Goals

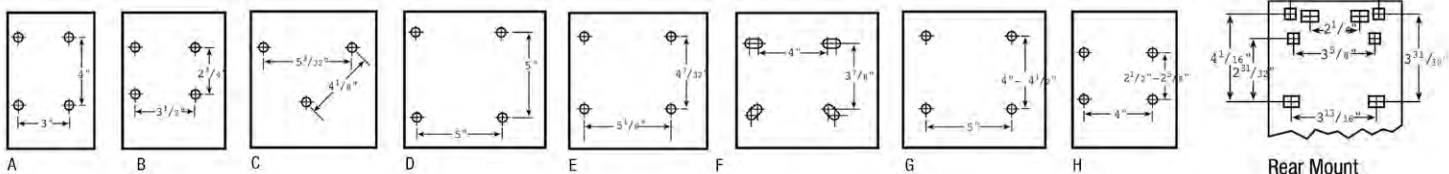

Field Hockey

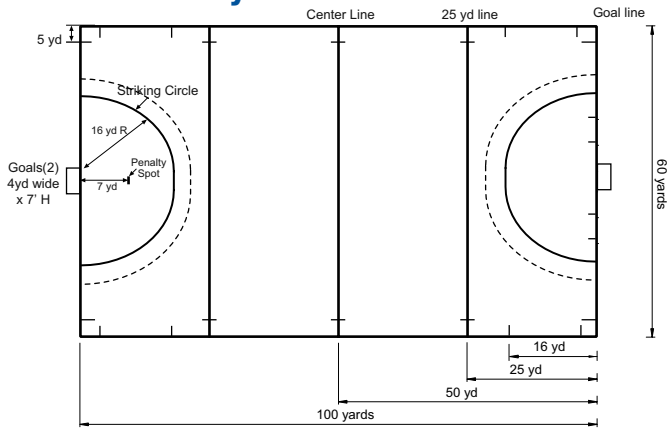

Tennis

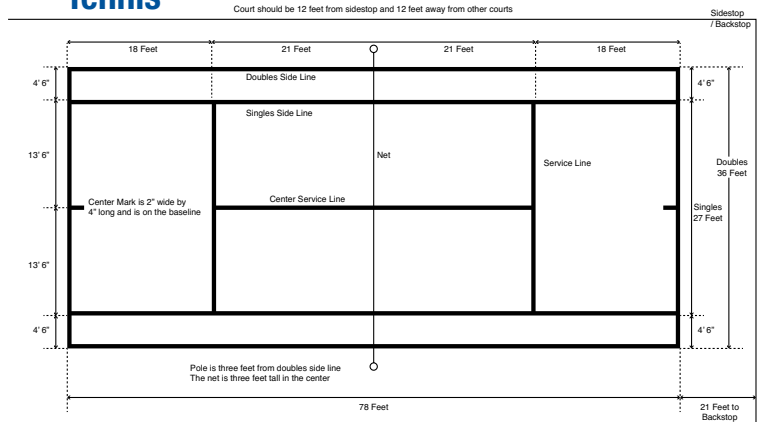

Team Handball

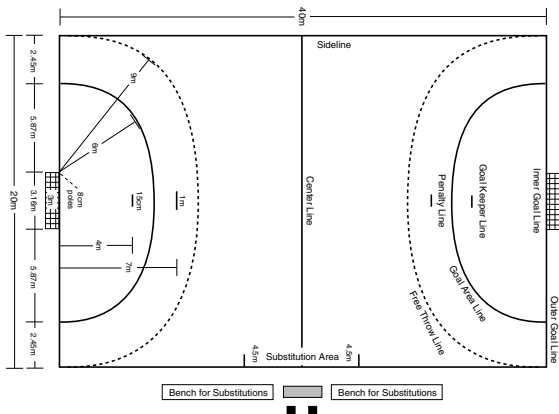

Badminton

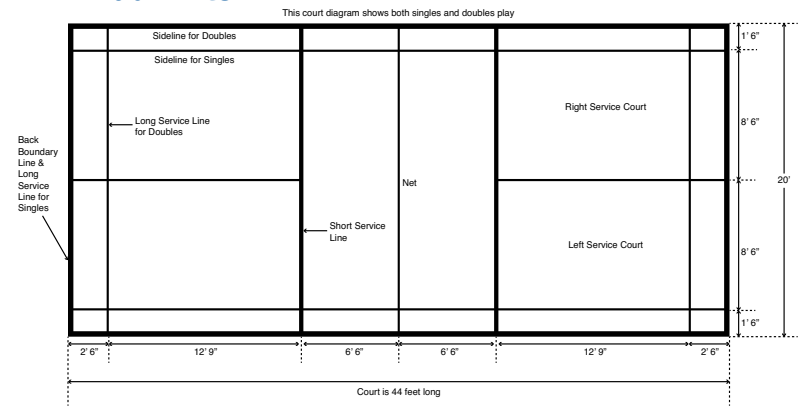

Rugby

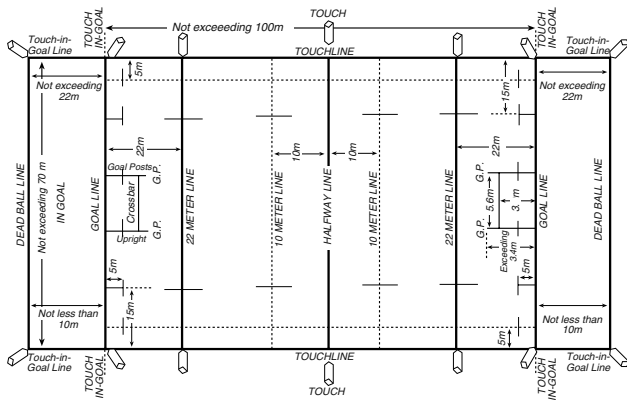

Pickleball

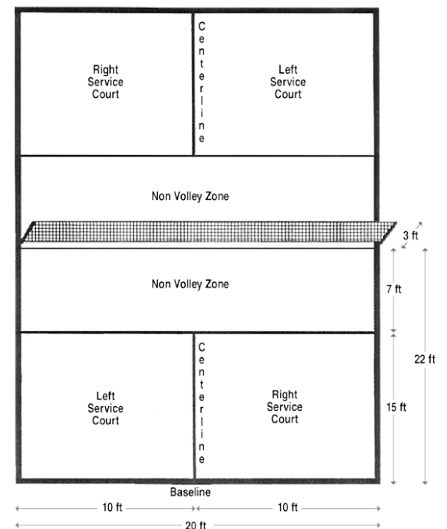

Ice Hockey

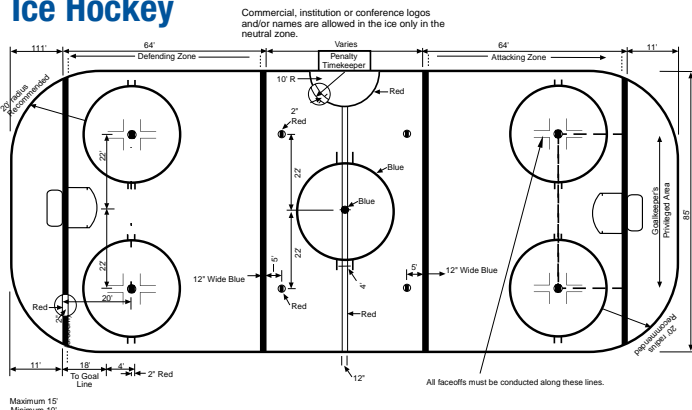

These court and field diagrams are provided for general reference only. It is your responsibility to confirm current rules and dimensions for your specific needs.



MODEL NUMBER INDEX

ABC50.....	10-11	BA495.....	19,94	BA871-BK.....	82	BLO0704AXLAA.....	78	BNP2101BAA.....	79	OFX4235E-XX.....	16
ABC51.....	74,91	BA495E.....	94	BA871XL-BK.....	82	BLO1502A.....	78	BNP21CVGRAA.....	80	OFX483180-XX.....	16
ABC52.....	58,74,91	BA495P.....	95	BA872PP-BK.....	91	BLO1502AA.....	78	BNP21CVSHAA.....	80	OFX4835E-XX.....	16
ABC53.....	58,74,91	BA50.....	98	BA873-BK.....	82	BLO1502AXL.....	78	BWA2-07-SM.....	99	PB100BP.....	14
ABC54.....	58	BA501H.....	98	BA873U.....	82-83	BLO1502AXLAA.....	78	BYOB161.....	81	PB130.....	14
ABC92.....	24	BA51H.....	21,98	BA874-BK.....	82-83	BLO1503A.....	78	BYOB163.....	81	PB150BB.....	14
BA10.....	98	BA52H.....	98	BA894GJR.....	11	BLO1503AA.....	78	BYOB164.....	81	PB150C.....	14
BA100.....	24	BA53.....	98	BA894GSR.....	11	BLO1503AXL.....	78	CM100.....	98	PB180.....	14
BA125.....	24	BA54U-BK.....	91	BA895G.....	11	BLO1503AXLAA.....	78	CM111.....	98	PB220.....	14
BA150.....	24	BA54U-GR.....	91	BA898G.....	10	BLO1504A.....	78	CM200.....	98	PC101-72.....	99
BA165.....	24	BA56W.....	98	BA898GDL.....	10	BLO1504AA.....	78	COLOR OPTIONS.....	102	PC401-FT.....	99
BA175.....	24,62	BA600YF.....	16	BA898HD.....	10	BLO1504AXL.....	78	DN12.....	15	PC450-FT.....	99
BA185.....	24	BA600YR.....	16	BA899QC-AW.....	100	BLO1504AXLAA.....	78	DN1250.....	15	PK10.....	65
BA21.....	22,97	BA60U-BK.....	91	BA925.....	7	BLO2103A.....	78	DN50.....	15	PK10CS.....	65
BA21A.....	22,97	BA60U-GR.....	91	BA9250X.....	101	BLO2103AA.....	78	ES101-72.....	99	PK10N.....	65
BA245.....	24	BA658YF.....	16	BA930.....	7	BLO2103AXL.....	78	FB04EM.....	74	PK10P.....	65
BA26.....	22	BA658YR.....	16	BA931.....	6	BLO2103AXLAA.....	78	FB100KC.....	74	PKG14STFS.....	8
BA27.....	22,96	BA68F.....	17	BA935.....	7	BLO2104A.....	78	FB10EXT-SY.....	74	PKG14STRG.....	8
BA27A.....	22,96	BA68U.....	17	BA9350.....	101	BLO2104AA.....	78	FB10EXT-WT.....	74	PKG250.....	9
BA28.....	96	BA700PP.....	91	BA955.....	7	BLO2104AXL.....	78	FB35-GV.....	74	PKG275.....	9
BA3180S.....	20	BA72U-BK.....	91	BA955RP.....	7	BLO2104AXLAA.....	78	FB45CG-SY.....	73	PKG300.....	9
BA3180T.....	20	BA770SSH.....	93	BA975A3.....	7	BM10.....	64	FB45CG-WT.....	73	PKG46SFRG.....	4
BA31N.....	97	BA775.....	92	BA975A4.....	7	BM10N.....	14,64	FB45HS-SY.....	73	PKG46STRG.....	4
BA31U.....	97	BA776.....	92	BA975CLKS.....	6	BM10P.....	64	FB45HS-WT.....	73	PKG48STFS.....	8
BA32.....	22,96	BA776A.....	92	BA975KS.....	6	BM21.....	63,64,65	FB45S.....	73	PKG48STRG.....	8
BA32RXT.....	22,97	BA776DB.....	92	BA980.....	7	BM300A.....	65	FB55CG-SY.....	73	PKG500.....	8
BA32XL.....	21	BA777.....	92	BA980EW.....	6	BM30-CV.....	63	FB55CG-WT.....	73	PKG600.....	8
BA33U.....	96	BA777UP.....	88	BA980F.....	6	BM350A.....	65	FB55HSCG-SY.....	73	PKG650.....	8
BA34.....	21	BA777XL.....	92	BA980RS.....	6	BM400A.....	65	FB55HSCG-WT.....	73	PKG675.....	8
BA35.....	21	BA778.....	92	BA980RSE.....	6	BN144.....	39	FB55HS-SY.....	73	PKG68SFRG.....	4
BA35A.....	20	BA778A.....	92	BA980RT.....	6	BN144R1.....	39	FB55HS-WT.....	73	PKG68STRG.....	4
BA35ARC.....	21	BA778DB.....	92	BA980RTE.....	6	BN144R2.....	39	FB55S.....	73	PKG82SFRG.....	4
BA35E.....	20	BA77XBR.....	93	BALED.....	19	BNF0701A.....	79	FB58CG-SY.....	73	PKG82STRG.....	4
BA35S.....	21	BA780.....	93	BFU2-02-SM.....	99	BNF0701AA.....	79	FB58CG-WT.....	73	PKGFBSCHSV-WT.....	71
BA37.....	96	BA780XL.....	93	BLO4SEAT1.....	79,81	BNF0701BA.....	79	FB58GSCG-WT.....	73	PKGFBSCHS-WT.....	71
BA37N.....	96	BA781.....	93	BLO7SEAT1.....	79,81	BNF0701BAA.....	79	FB58HSCG-SY.....	73	PKGFBSGS-SY.....	71
BA39U.....	96	BA781A.....	92	BL15SEAT1.....	79,81	BNF1501A.....	79	FB58HS-SY.....	73	PR12.....	85
BA39U-GV.....	96	BA781DB.....	93	BL21SEAT1.....	79,81	BNF1501AA.....	79	FB58HS-WT.....	73	PR15.....	83
BA407C.....	19	BA79UPP-BK.....	91	BLOI0702A.....	77	BNF1501BA.....	79	FBCPP.....	74,87,91	PR16.....	84
BA407G.....	19	BA800.....	12	BLOI0702AA.....	77	BNF1501BAA.....	79	FBCPPW.....	74	PR17.....	83
BA407U.....	95	BA800FL.....	12	BLOI0703A.....	77	BNF2101A.....	79	FBRUGBY.....	74	PR20.....	89
BA42E.....	18	BA801.....	85	BLOI0703AA.....	77	BNF2101AA.....	79	FBWDS.....	74	PR29.....	89
BA42UC.....	95	BA801BP.....	15,85	BLOI0704A.....	77	BNF2101BA.....	79	FH200.....	76	PR30.....	89
BA42XL.....	18	BA803.....	14	BLOI0704AA.....	77	BNF2101BAA.....	79	FH200N.....	76	PR31.....	89
BA42XLC.....	18	BA803A.....	14	BLI1502A.....	77	BNP0401BCA.....	81	FH200WK.....	76	PR33.....	89
BA44XL.....	19	BA8250X.....	101	BLI1502AA.....	77	BNP0701A.....	79	HK050N.....	75	PR50.....	88
BA454.....	94	BA832.....	13	BLI1503A.....	77	BNP0701AA.....	79	HK500.....	75	PR52.....	88
BA454AW.....	95	BA833.....	13	BLI1503AA.....	77	BNP0701BA.....	79	HK500P.....	75	PR55.....	88
BA455.....	19	BA833BLST.....	13	BLI1504A.....	77	BNP0701BAA.....	79	HK50U.....	75	PR60.....	88
BA465.....	19	BA833XL.....	13	BLI1504AA.....	77	BNP07CVGRAA.....	80	LC050N.....	75	PR70.....	88
BA47.....	94	BA834.....	13	BLI2102A.....	77	BNP07CVSHAA.....	80	LC200.....	75	PR70G.....	88
BA472.....	94	BA8350.....	101	BLI2102AA.....	77	BNP1500XL.....	80	LC300.....	75	PR74.....	86
BA472PC.....	94	BA853A.....	12	BLI2103A.....	77	BNP1501A.....	79	MC101-72.....	99	PR75.....	86
BA475.....	95	BA853BLST.....	12	BLI2103AA.....	77	BNP1501AA.....	79	MC106-72.....	99	PR75XL.....	87
BA475SS.....	95	BA853G.....	12	BLO0703A.....	78	BNP1501BA.....	79	MC402-FT.....	99	PR76.....	86
BA475W.....	95	BA853GXL.....	12	BLO0703AA.....	78	BNP1501BAA.....	79	MC450-FT.....	99	PR77.....	86
BA48.....	18	BA870AXL.....	82	BLO0703AXL.....	78	BNP15CVGRAA.....	80	OFX4234-XX.....	16	PR77XL.....	87
BA485.....	94	BA870JRPP.....	91	BLO0703AXLAA.....	78	BNP15CVSHAA.....	80	OFX4235E-XX.....	16	PR78.....	86
BA48U-BK.....	91	BA870PP-BK.....	91	BLO0704A.....	78	BNP2101A.....	79	OFX4234-XX.....	16	PR79.....	86
BA48XL.....	18	BA871A-BK.....	82	BLO0704AA.....	78	BNP2101AA.....	79	OFX4834-XX.....	16	PR79XL.....	87
BA48XLC.....	18	BA871A-GV.....	82-83	BLO0704AXL.....	78	BNP2101BA.....	79	OFX423180-XX.....	16	PR87.....	86



PR87XL.....87	SC2480IGA FB.....71	SVB1000.....56	VB2000NS.....48	VB73.....58	WP64.....35
PR94U.....85	SC2480PA24E.....69	SVB1002.....56	VB2002.....48	VB73A.....58	WP6416.....35
PR95U.....85	SC2480PA24NT.....69	SVB1250K.....56,60	VB2002NS.....48	VB7658	WP6416F.....35
PR98G.....84	SC2480PA40E67	SVB2000A.....57	VB21.....57,63	VB77.....44	WP6416G.....35
PR98S.....84	SC2480PA40EURO.....68	SVB210.....57	VB22.....63	VB7702.....44	WP6416L.....35
PR98U.....84	SC2480PA40NT.....67	SVB23.....56	VB23.....63	VB7702NS.....44	WP64F.....35
PR99.....87	SC2480PA44E67	SVB26.....56	VB230.....63	VB777.....44	WP64G.....35
PR99XL.....87	SC2480PA44F.....68	SVB27.....56	VB235.....63	VB7777.....44	WP64L.....35
SC00EB.....70	SC2480PA44FB.....71	SVB28.....56	VB23CH.....63	VB7777NS.....44	WP72.....35
SC00PP.....72	SC2480PA44NT.....67	SVB400.....57	VB23CH-CV.....63	VB80JR.....53	WP7216.....35
SC01PP.....72	SC2480PA44XL.....68	SVB50.....57	VB23-CV.....63	VB810.....52,53	WP7216F.....35
SC02BSA.....70,71	SC24PP.....72	SVB500.....57	VB23IK.....61	VB810BASE.....53	WP7216G.....35
SC03PP.....76	SC34BI.....72	SVB5000.....57	VB23LK-CV.....63	VB8100.....52	WP7216L.....35
SC045N.....70	SC40PP.....72	SVB5050.....57	VB24.....63	VB8100JR.....53	WP72F.....35
SC04GA.....72	SC44P.....72	SVB5050W.....55	VB25.....63	VB8100LOW.....52	WP72G.....35
SC04SM.....72	SC44S.....70,71	SVB73.....56,58	VB25FL.....63	VB8102.....52	WP72L.....35
SC04WK.....72	SC450I.....25	TB100.....64	VB25TF.....63	VB8102DJ.....52	WP74.....35
SC04WKU.....72	SC450S.....25	TB100P.....64	VB26.....63	VB8102JR.....53	WP7416.....35
SC050N.....70	SC500.....25	TB300.....64	VB26CH.....63	VB810JR.....53	WP7416F.....35
SC055N.....70	SC50B.....72,76	TB50-B.....64	VB27.....63	VB810P.....53	WP7416G.....35
SC060N.....70	SC72NC.....72	TN05.....65	VB27CH.....63	VB82.....54	WP7416L.....35
SC06CF.....72	SC900.....25	TN10.....65	VB30.....46	VB8200.....54	WP74F.....35
SC06CFW.....72	SCBKT2.....10	TN10CS.....65	VB300.....46	VB8250.....54	WP74G.....35
SC06DK.....72	SCFUTSAL.....76	TN10N.....65	VB3000.....46	VB82P.....54	WP74L.....35
SC071N.....70	SCFUTSALN.....76	TN23.....65	VB3000NS.....46	VB90.....51	WP82.....35
SC072N.....70	SCNOTIP.....72	TN235.....65	VB3002.....46	VB900.....51	WP8216.....35
SC075N.....70	SCTEAMHB.....76	TN500BNP.....65	VB3002NS.....46	VB9000.....51	WP8216F.....35
SC080N.....70	ST125F.....28	TR22.....22	VB335.....63	VB9000NS.....51	WP8216G.....35
SC0945IGA.....70	ST125FL.....28	TR23.....22	VB340.....63	VB9002.....51	WP8216L.....35
SC0945PA24E.....69	ST125FS.....28	TR70RP.....22	VB354.....63	VB9002NS.....51	WP82F.....35
SC095N.....70	ST45B.....28	TR74.....22	VB35P.....61	VB9130.....59	WP82G.....35
SC10.....72	ST45BL.....28	TR75.....22	VB40.....49	VB9135.....59	WP82L.....35
SC1000.....25	ST45BS.....28	TR76.....22	VB400.....49	VB9140.....59	WP84.....35
SC100N.....70	ST45F.....28	TR76.....22	VB4000.....49	VB92.....59	WP8416.....35
SC106N.....70	ST45FI.....27	TR95.....91	VB4002.....49	VB94.....59	WP8416F.....35
SC1265IGA.....70	ST45FL.....28	TR96.....91	VB510P.....58	VB95.....59	WP8416G.....35
SC1265PA24E.....69	ST45FS.....28	VB0050.....55	VB51P.....58	VB96.....59	WP8416L.....35
SC1865IGA.....70	ST54F.....30	VB01XL.....62	VB51PL.....58	VB98HG.....61	WP84F.....35
SC1865PA24E.....69	ST83F.....30	VB10.....47	VB51PW.....58	VB99HG.....61	WP84G.....35
SC1865PA24NT.....69	ST84F.....30	VB100.....47	VB60.....50	VBDSS.....63	WP84L.....35
SC1865PA40E.....67	ST85B28	VB100047	VB600.....50	VBTBASE.....55	WPC.....36
SC1865PA40EURO.....68	ST85BL.....28	VB1000NS47	VB6000.....50	VBVELCRO.....61	WPRAIL.....37
SC1865PA40NT.....67	ST85BS.....28	VB1000T.....55	VB6000.....50	WP20F.....32	WPRAILCT.....37,38
SC1865PA44E.....67	ST85F27,28	VB100247	VB6000NS.....50	WP25.....32	WPV.....36
SC1865PA44F.....68	ST85FI.....27	VB1002NS47	VB6000T.....55	WP466.....32	WPZ.....36
SC1865PA44NT.....67	ST85FL.....28,29	VB10T.....53	VB6002.....50	WP52.....35	WS144G.....38
SC1865PA44XL.....68	ST85FS.....28,29	VB1200RR.....61	VB6002NS.....50	WP52F.....35	
SC2000.....25	ST870.....29	VB123.....61	VB6050.....50	WP52G.....35	
SC20ER.....25	ST89F.....30	VB1250K.....60	VB6050NS.....50	WP52L.....35	
SC20WR.....25	STC036.....31	VB1250KU60	VB70.....45	WP54.....35	
SC2170IGA.....70	STC100.....31	VB1250SP.....60	VB700.....45	WP54F.....35	
SC2170PA24E.....69	STC300S.....31	VB1250ST.....60	VB7000.....45	WP54G.....35	
SC2170PA24NT.....69	STC500S.....31	VB1251W.....59	VB7000NS.....45	WP54L.....35	
SC2170PA40E.....67	STR10WBF.....5	VB1252W.....59	VB7002.....45	WP62.....35	
SC2170PA40EURO.....68	STR10WBR.....5	VB1253W.....59	VB7002NS.....45	WP6216.....35	
SC2170PA40NT.....67	STR12WFUF.....5	VB1298.....60	VB72.....43	WP6216F.....35	
SC2170PA44E.....67	STR12WFUR.....5	VB1361	VB7202.....43	WP6216G.....35	
SC2170PA44F.....68	STR15WSFF.....5	VB185.....62	VB7202NS.....43	WP6216L.....35	
SC2170PA44NT.....67	STR15WSFR.....5	VB20.....48	VB722.....43	WP62F.....35	
SC2170PA44XL.....68	SVB08.....14,57	VB200.....48	VB7222.....43	WP62G.....35	
SC2480IGA.....70	SVB100.....56	VB2000.....48	VB7222NS.....43	WP62L.....35	

Value priced items are indicated in green.



BEN SHAFFER RECREATION Inc.

Serving NJ since 1921



PARK, PLAYGROUND & STREETScape SOLUTIONS

1-800-953-2021

www.benshaffer.com

sales@benshaffer.com

DREAM * DESIGN * DELIVER

PRSRT STD
US POSTAGE

PAID
LINCOLN, NE
Permit #553

30M/10-15

A GOAL FOR EVERY GAME

**Basketball Volleyball Football Soccer Lacrosse Futsal
Team Handball Rugby Tennis Tetherball Badminton Hockey**



**OVER
\$1,500
of Coupons Inside**



SBVB

**OVER
\$1,000
of Coupons Inside**



SBSC

**OVER
\$500
of Coupons Inside**



SBBB

Bison Team Scorebooks

All Bison scorebooks provide clear, crisp scoring pages for a season of winning games or matches. These scorebooks have durable, full color front covers, scorekeeping instructional pages and all the features you'd expect in a premium competition scorebook. Available for basketball, volleyball or soccer, each with capacity for up to 30 games or matches.

Exclusive Bison bonus...Each scorebook contains factory rebate coupons good for sport-specific Bison products needed throughout the year • Bison team sports equipment is sold only through Quality Team Sports Dealers • All Bison scorebooks are sold individually. Approx. shipping weight: 1#/each; 5m. Pkg.

**NJ State
Contract!**